

D I O
P R O D U C T
C A T A L O G



DIO USA

3470 Wilshire blvd.,#620,
Los Angeles
CA 90010 USA

T 213-365-2875

E usahq@dioimplantusa.com

UFII Int. Submerged System

Digital Materials

DIONavi. Surgical Kit

Surgical Kit



DIO

PRODUCT CATALOG

UFII Int. Submerged System

Digital Materials

DIOnavi. Surgical Kit

Surgical Kit

※ This catalog contains all products of DIO Corporation.

Please check with your local sales office and your sales representative if you are able to order products.

D I O

P R O D U C T

C A T A L O G

UF II Int. Submerged System



013
UF II
Narrow
Fixture
ø3.0 ø3.3



016
Cover
Screw



017
Healing
Abutment



Cement / Screw – Retained Restorations

022
Pick-up
Impression
Coping



025
Temporary
Abutment



029
Angled
Abutment



024
Fixture
Analog



023
Transfer
Impression
Coping



026
Cemented
Abutment



Abutment
Screw



Cement – Retained Restorations

033
Solid
Abutment



034
Protect
Cap



034
Impression
Cap



035
Solid
Abutment
Analog



035
Plastic
Coping



Overdenture – Retained Restorations

043
Ball
Abutment



044
Ball
Abutment
Analog



045
Housing
OT Cap



Surgical Kit

052
UF II Master kit
※Surgical / Prosthetics Tool



053
UF II Surgical Kit
※Surgical Tool

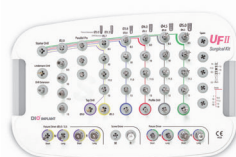

066
UF II Narrow kit

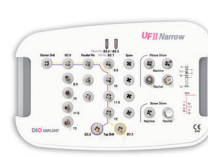

070
UF II Wide Kit





014
 UFI
 Regular
 Ø3.8/4.0/4.5/5.0/5.5
 Wide
 Ø5.9/6.4/6.9



016
 Cover
 Screw



017
 Healing
 Abutment



Cement / Screw - Retained Restorations

022
 Pick-up
 Impression
 Coping



025
 Temporary
 Abutment



028
 Mill
 Abutment



029
 Angled
 Abutment



023
 Transfer
 Impression
 Coping



024
 Fixture
 Analog



026
 Cemented
 Abutment



030
 UCLA
 CCM·Gold
 Plastic
 Abutment



Abutment
 Screw



Cement - Retained Restorations

033
 Solid
 Abutment



034
 Protect
 Cap



034
 Impression
 Cap



035
 Solid
 Abutment
 Analog



035
 Plastic
 Coping



Screw - Retained Restorations

037
 Octa
 Abutment



038
 Pick-up
 Impression
 Coping



038
 Octa
 Abutment
 Analog



039
 Temporary
 Cylinder



040
 Gold
 Cylinder



037
 Healing
 Cap



038
 Transfer
 Impression
 Coping



039
 Cemented
 Cylinder



040
 Plastic
 Cylinder



Cylinder
 Screw



Overdenture - Retained Restorations

043
 Ball
 Abutment



044
 Ball
 Abutment
 Analog



044
 Housing
 OT Cap



045
 Ball Cap
 Retainer
 O-ring



Screw - Retained Restorations

047
 Multiunit
 Straight
 Abutment



048
 H
 Scanbody



049
 Scan
 Adapter



051
 Digital
 Analog



050
 UCLA
 CCM·Plastic
 Temporary
 Cemented
 Cylinder



047
 Multiunit
 Angled
 Abutment



048
 Pick-up
 Impression
 Coping



048
 Transfer
 Impression
 Coping



051
 Abutment
 Analog



Cylinder
 Screw



Digital Materials

Anatomic Abutment

077
Lower Incisor
UF II Int. Sub. Narrow
Anatomic Abutment



078
Upper Incisor
UF II Int. Sub. Narrow
Anatomic Abutment



079
Upper Incisor
UF II Int. Sub.
Anatomic Abutment



0780
Canine
UF II Int. Sub.
Anatomic Abutment



081
Premolar
UF II Int. Sub.
Anatomic Abutment



082
Molar
UF II Int. Sub.
Anatomic Abutment



Scan Adapter

085
UF II
Int. Sub.
Narrow



085
UF II
Int. Sub.
Regular
Wide



Digital Materials

086
Scan
Retractor



086
Wax
Denture



086
Marker



Pre - Milled Bar

087
UF II
Int. Sub.
Narrow



087
UF II
Int. Sub.
Regular
Wide



Hybrid Link

088
UF II
Int. Sub.
Narrow



088
UF II
Int. Sub.
Regular
Wide



DIONavi. Surgical Kit

092
DIONavi. Master Kit

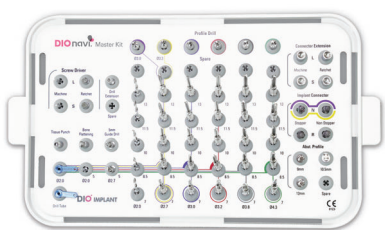

101
DIONavi. Narrow Kit

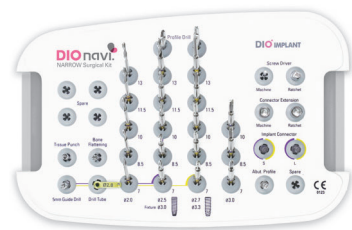

107
DIONavi. Wide Kit



113
DIONavi. Flapless Crestal Sinus Kit



116
DIONavi. Special Kit

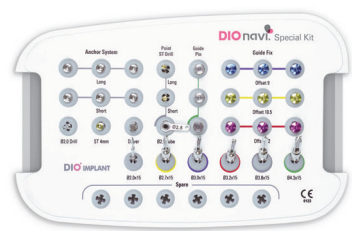

Surgical Kit

124
Sinus Master Kit

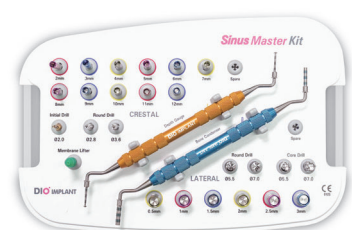

131
Dr. SOS+ Kit

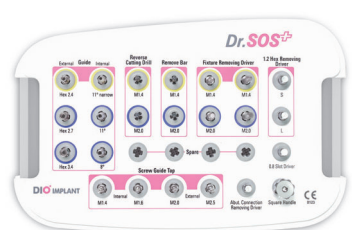

DIO
www.dionavi.com

IMPLANT SYSTEM

IMPLANT SYSTEM

DIO PRODUCT CATALOG

Implant Surface Treatment Feature

Hybrid Type SLA Implant

UFII Implant

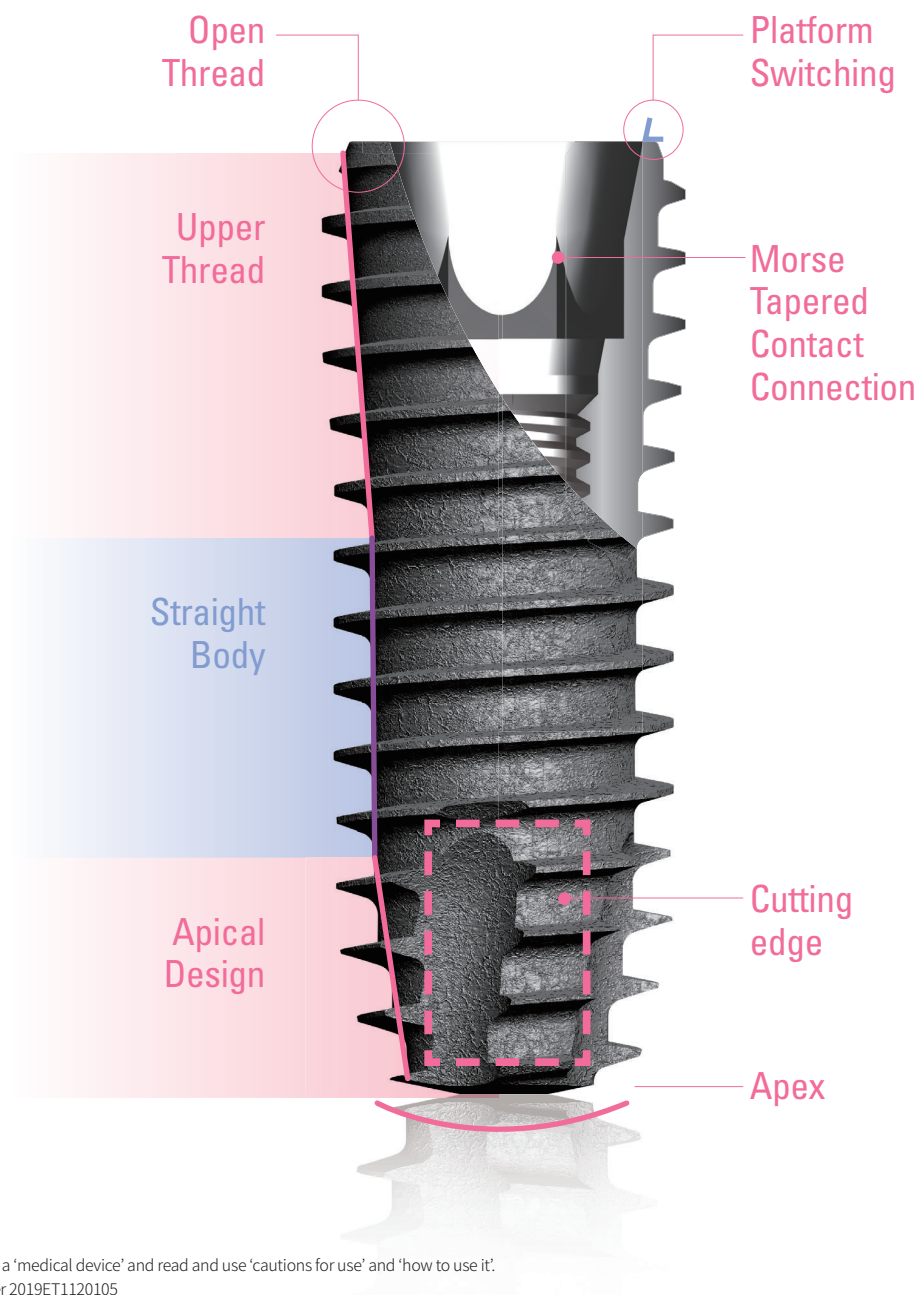
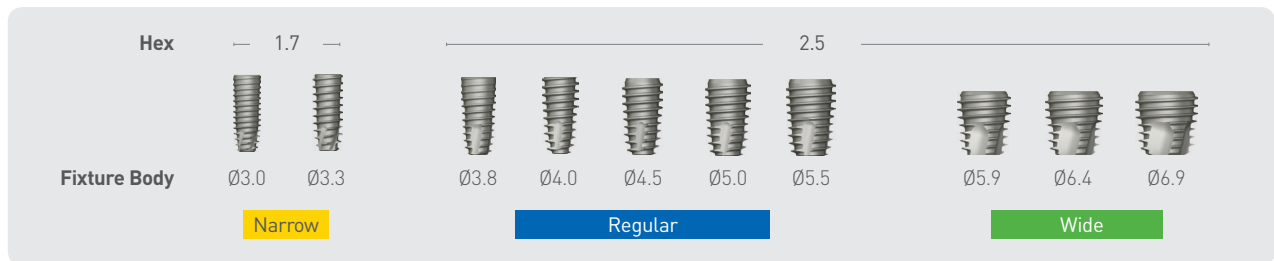

Hybrid Type SLA Implant

UFII Implant Surface HSA

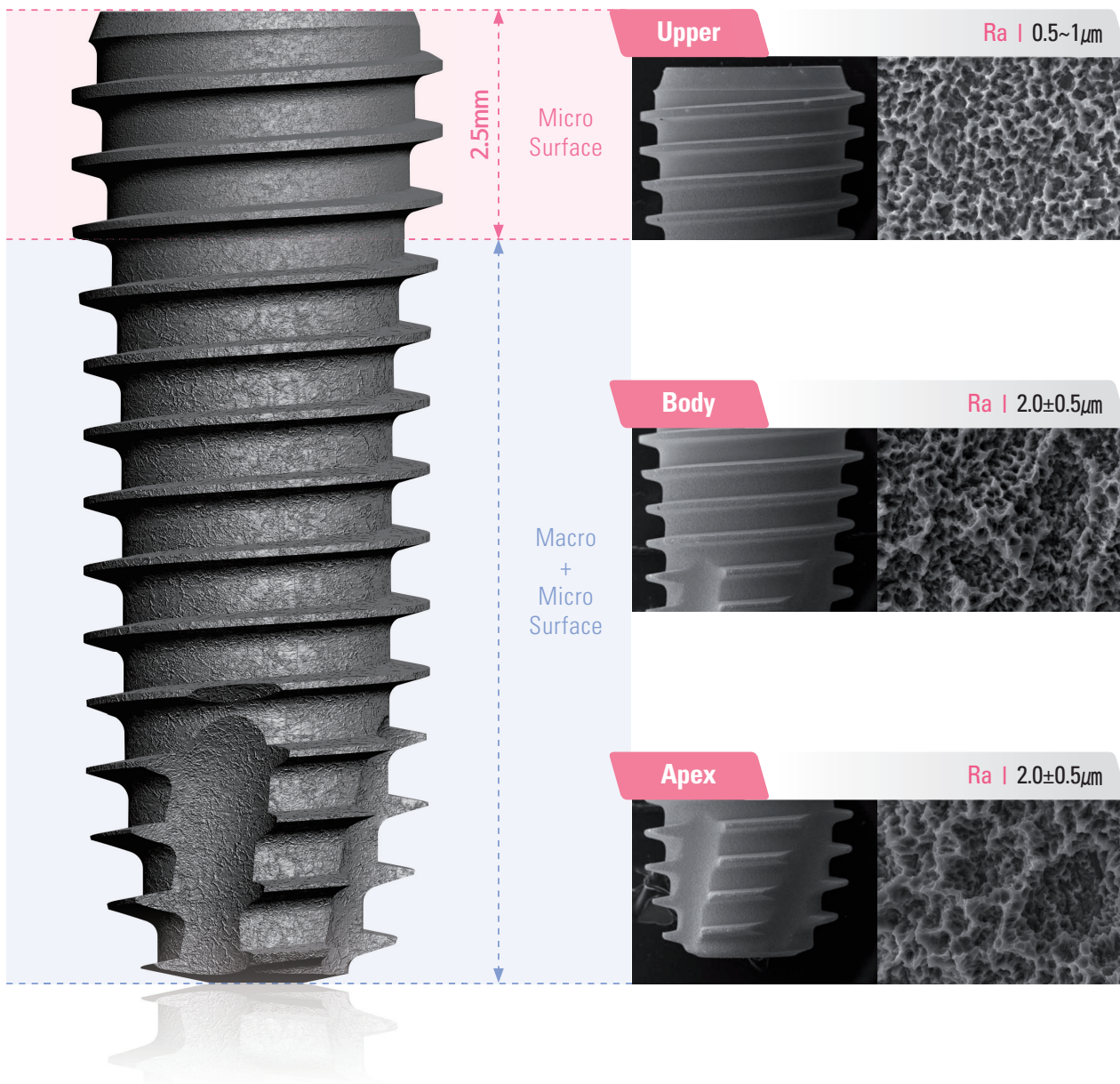

UFII Int. Submerged System

UFII Narrow

D $\emptyset 3.0$ | $\emptyset 3.3$
 L 8.5 | 10 | 11.5 | 13 | 15

HSA

UV Active

UFII Regular

D $\emptyset 3.8$ | $\emptyset 4.0$ | $\emptyset 4.5$ | $\emptyset 5.0$ | $\emptyset 5.5$
 L 7 | 8.5 | 10 | 11.5 | 13 | 15 | 16

HSA

UV Active

UFII Wide

D $\emptyset 5.9$ | $\emptyset 6.4$ | $\emptyset 6.9$
 L 7 | 8.5 | 10 | 11.5 | 13

HSA

UV Active

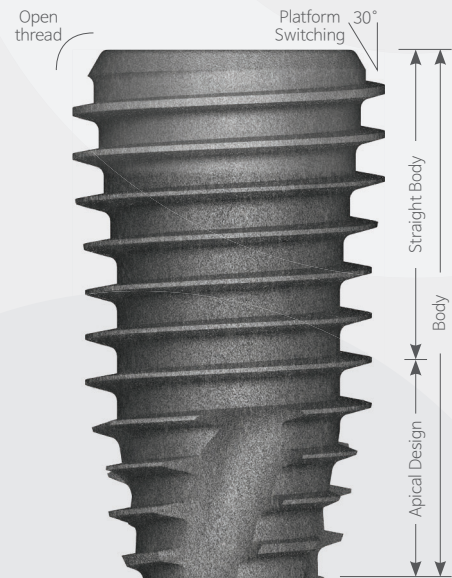
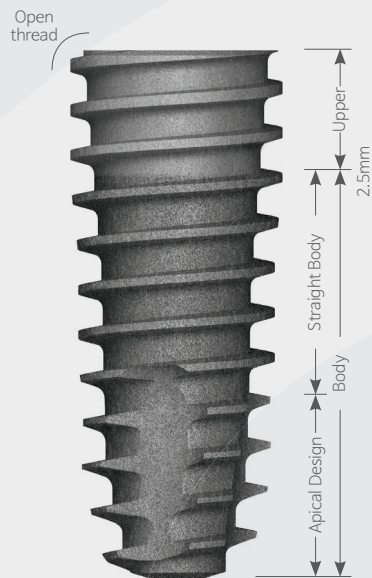
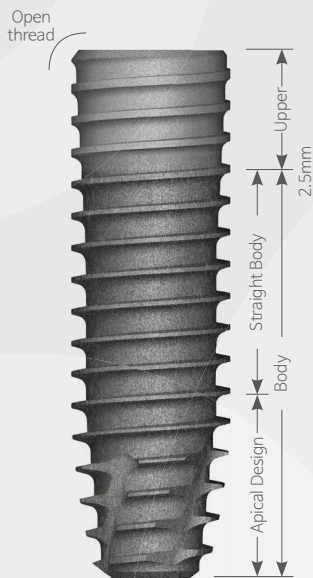
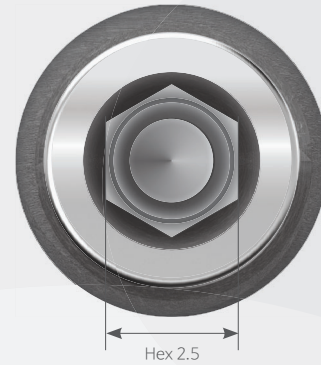
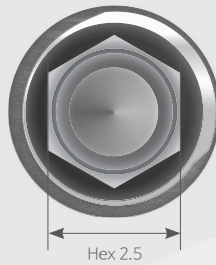
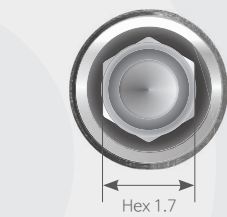

UFII Narrow

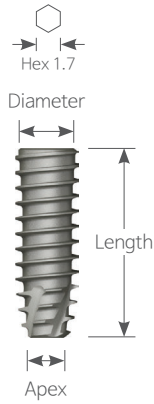

UFII Regular

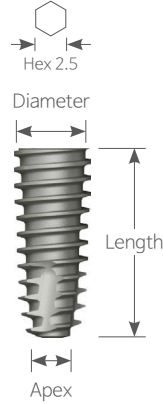

UFII Wide

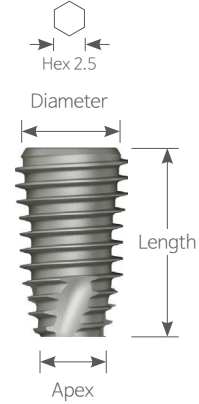

Narrow Fixture

► Ø3.0 fixture exclusive for anterior teeth

· HSA / Packing Unit :

Fixture | Order code : Product Code + SF (ex : UF(II)N 3008SF)

Fixture & Coverscrew | Order code : Product Code + S (ex : UF(II)N 3008S)

· UV Active / Packing Unit : Fixture

N D Ø3.0 Hex 1.7 Apex Ø1.6

Unit mm | Scale 1 : 1.2

Length	8.5	10	11.5	13	15
--------	-----	----	------	----	----



HSA | UF(II)N 3008SF UF(II)N 3010SF UF(II)N 3011SF UF(II)N 3013SF UF(II)N 3015SF
 UV Active | UF(II)N 3008UV3 UF(II)N 3010UV3 UF(II)N 3011UV3 UF(II)N 3013UV3 -

N D Ø3.3 Hex 1.7 Apex Ø1.9

Length	8.5	10	11.5	13	15
--------	-----	----	------	----	----



HSA | UF(II)N 3308SF UF(II)N 3310SF UF(II)N 3311SF UF(II)N 3313SF UF(II)N 3315SF
 UV Active | UF(II)N 3308UV3 UF(II)N 3310UV3 UF(II)N 3311UV3 UF(II)N 3313UV3 -

Regular Fixture

· HSA / Packing Unit :

Fixture | Order code : Product Code + SF (ex : UF(II) 3808SF)







Fixture & Coverscrew | Order code : Product Code + S (ex : UF(II) 3808S)

Fixture Mount +Mount Screw + Fixture + Cover Screw | Order code : P+Product Code+S (ex : PUF(II) 3808S)







· UV Active / Packing Unit : Fixture

R D Ø3.8 Hex 2.5 Apex Ø2.9







Unit mm | Scale 1 : 1.2

Length	7	8.5	10	11.5	13	15	16
							
HSA	-	UF(II) 3808SF	UF(II) 3810SF	UF(II) 3811SF	UF(II) 3813SF	UF(II) 3815SF	UF(II) 3816SF
UV Active	-	UF(II) 3808UV3	UF(II) 3810UV3	UF(II) 3811UV3	UF(II) 3813UV3	-	-







R D Ø4.0 Hex 2.5 Apex Ø2.9







Length	7	8.5	10	11.5	13	15	16
							
HSA	-	UF(II) 4008SF	UF(II) 4010SF	UF(II) 4011SF	UF(II) 4013SF	UF(II) 4015SF	UF(II) 4016SF
UV Active	-	UF(II) 4008UV3	UF(II) 4010UV3	UF(II) 4011UV3	UF(II) 4013UV3	-	-

R D Ø4.5 Hex 2.5 Apex Ø3.4

Length	7	8.5	10	11.5	13	15	16
							
HSA	UF(II) 4507SF	UF(II) 4508SF	UF(II) 4510SF	UF(II) 4511SF	UF(II) 4513SF	UF(II) 4515SF	UF(II) 4516SF
UV Active	UF(II) 4507UV3	UF(II) 4508UV3	UF(II) 4510UV3	UF(II) 4511UV3	UF(II) 4513UV3	-	-





R D Ø5.0 Hex 2.5 Apex Ø3.9





Length	7	8.5	10	11.5	13	15	16
							
HSA	UF(II) 5007SF	UF(II) 5008SF	UF(II) 5010SF	UF(II) 5011SF	UF(II) 5013SF	UF(II) 5015SF	UF(II) 5016SF
UV Active	UF(II) 5007UV3	UF(II) 5008UV3	UF(II) 5010UV3	UF(II) 5011UV3	UF(II) 5013UV3	-	-





R D Ø5.5 Hex 2.5 Apex Ø4.5							
Length	7	8.5	10	11.5	13	15	16
							
HSA	UF(II) 5507SF	UF(II) 5508SF	UF(II) 5510SF	UF(II) 5511SF	UF(II) 5513SF	UF(II) 5515SF	UF(II) 5516SF
UV Active	UF(II) 5507UV3	UF(II) 5508UV3	UF(II) 5510UV3	UF(II) 5511UV3	UF(II) 5513UV3	-	-

Wide Fixture

- HSA / Packing Unit :
 Fixture | Order code : Product Code + SF (ex : UF(II) 6008SF)
 Fixture & Coverscrew | Order code : Product Code + S (ex : UF(II) 6008S)
 Fixture Mount +Mount Screw + Fixture + Cover Screw | Order code : P+Product Code+S (ex : PUF(II) 6008S)
- UV Active / Packing Unit : Fixture

W D Ø5.9 Hex 2.5 Apex Ø5.4						Unit mm Scale 1 : 1.2
Length	7	8.5	10	11.5	13	
						
HSA	UF(II) 6007SF	UF(II) 6008SF	UF(II) 6010SF	UF(II) 6011SF	UF(II) 6013SF	
UV Active	UF(II) 6007UV3	UF(II) 6008UV3	UF(II) 6010UV3	UF(II) 6011UV3	UF(II) 6013UV3	

W D Ø6.4 Hex 2.5 Apex Ø5.9					
Length	7	8.5	10	11.5	13
					
HSA	UF(II) 6507SF	UF(II) 6508SF	UF(II) 6510SF	UF(II) 6511SF	UF(II) 6513SF
UV Active	UF(II) 6507UV3	UF(II) 6508UV3	UF(II) 6510UV3	UF(II) 6511UV3	

W D Ø6.9 Hex 2.5 Apex Ø6.4					
Length	7	8.5	10	11.5	13
					
HSA	UF(II) 7007SF	UF(II) 7008SF	UF(II) 7010SF	UF(II) 7011SF	UF(II) 7013SF

Cover Screw

▶ Used for narrow area after the Implant surgery or to protect Implant connection area.

▶ Dental Implant cover screw is implanted into the top which helps to prevent tissue and bone to grow inside the implant.

· Uses 1.2 Hex Driver

· Method of use



① Screw installation after removing the remaining blood or foreign substance in Implant.

② Connect the screw using 1.2 hex driver and hand-tighten (5~8Ncm)

③ Remove the screw if cold-welding occurs between the screw and implant.

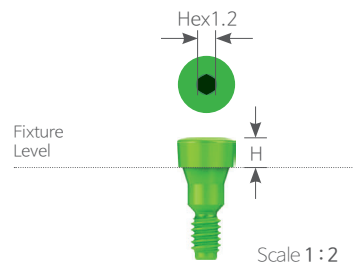
· Tightening Torque : 5~8Ncm



N R W Hex 1.2		Unit mm Scale 1 : 1.25		
Fixture Size	Narrow	Regular · Wide		
				
Height 0	UNSCS 2700	SSCS 3400	-	
1	UNSCS 2710	-	SSCS 3410	
2	UNSCS 2720	-	SSCS 3420	
3	UNSCS 2730	-	SSCS 3430	

Healing Abutment

- Uses 1.2 Hex Driver
- Uses 0.5 Slot Driver
- Tightening Torque : 5~8Ncm

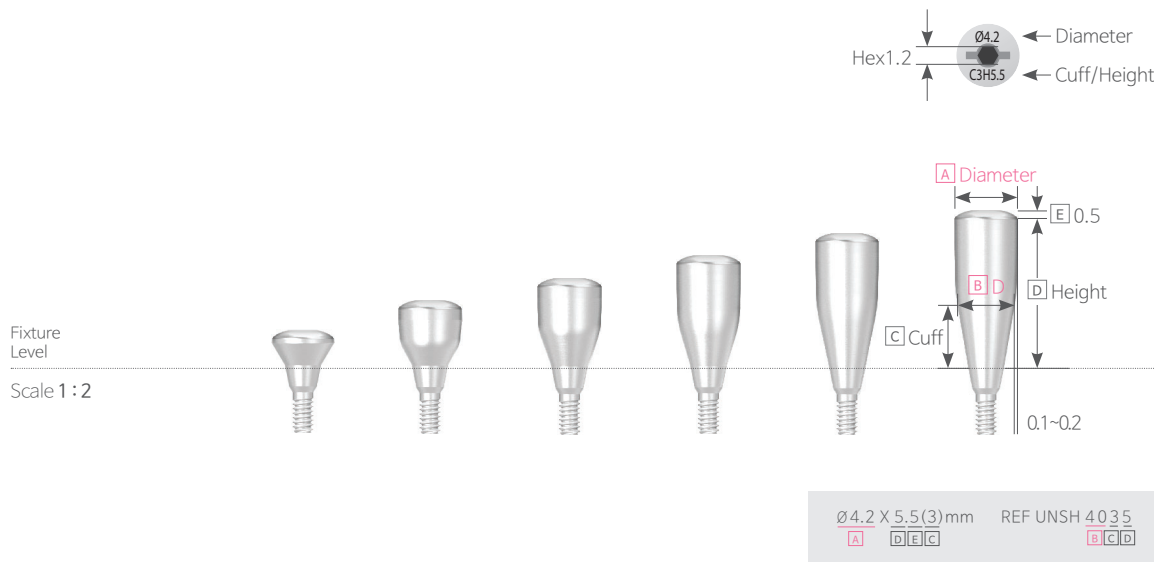

N Hex 1.2

Unit mm | Scale 1 : 1.25

Fixture Size

Narrow

Fixture Size	Ø4.1	Ø4.2	Ø4.6	Ø4.7
Height 2	UNSHA 4020	-	UNSHA 4520	-
4	-	UNSHA 4024	-	UNSHA 4524
5	-	UNSHA 4035	-	UNSHA 4535
7	-	UNSHA 4047	-	UNSHA 4547
8.5	-	UNSHA 4058	-	UNSHA 4558
10	-	UNSHA 4060	-	UNSHA 4560

Healing Abutment

- ▶ Used for small diameter abutment like Ball abutment
- ▶ Used if the fixture is deeply placed
- Uses 1.2 Hex Driver
- Uses 0.5 Slot Driver
- Tightening Torque : 5~8Ncm

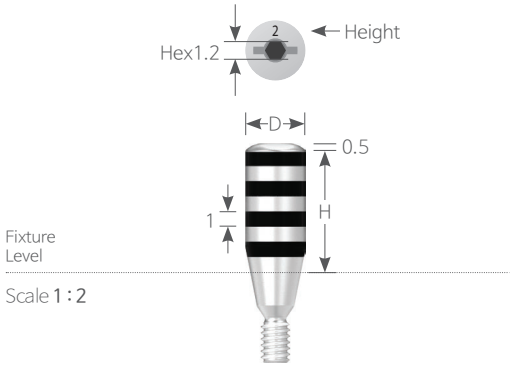

R W D Ø4.0 Hex 1.2 Unit mm | Scale 1 : 1.25

Fixture Size	Regular · Wide			
Height	2	4	6	8



- Uses 1.2 Hex Driver
- Uses 0.5 Slot Driver
- Tightening Torque : 5~8Ncm

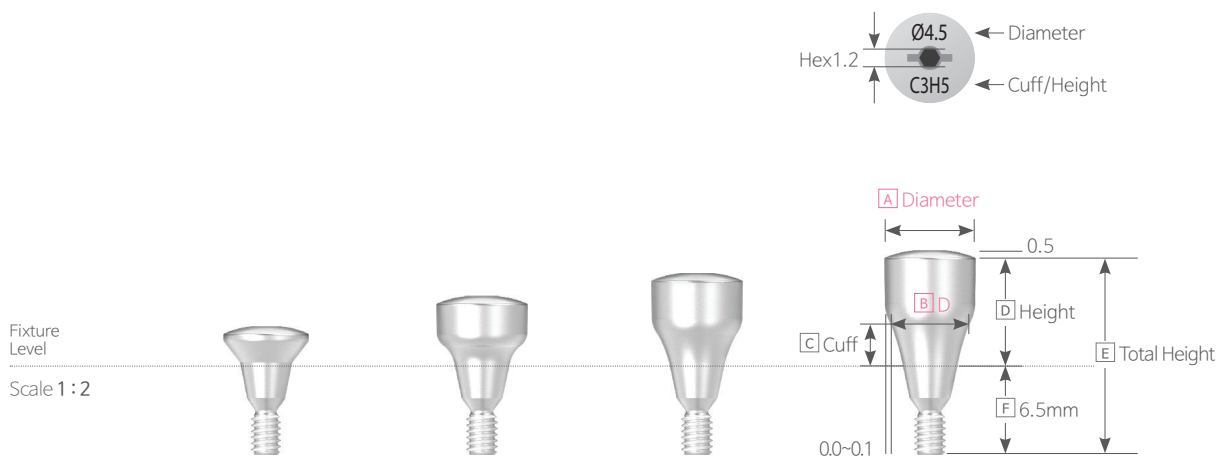

[A] & [E] is identical in Regular.
 [B] intend \varnothing in Regular.
 [E] = [D] + [F]
 Ø4.5 X 12(3)mm SSHA 45 35
 [B] [E] [C] [D]

R W Hex 1.2

Unit mm | Scale 1 : 1.25

Fixture Size

Regular · Wide



Height 2	SSHA 4520	SSHA 5520	SSHA 6520	SSHA 7520
4	SSHA 4524	SSHA 5524	SSHA 6524	SSHA 7524
5.5	SSHA 4535	SSHA 5535	SSHA 6535	SSHA 7535
7	SSHA 4547	SSHA 5547	SSHA 6547	SSHA 7547

Cement / Screw – Retained Restorations

Temporary / Cemented / Angled / UCLA Abutment

Fixture - **N R W**

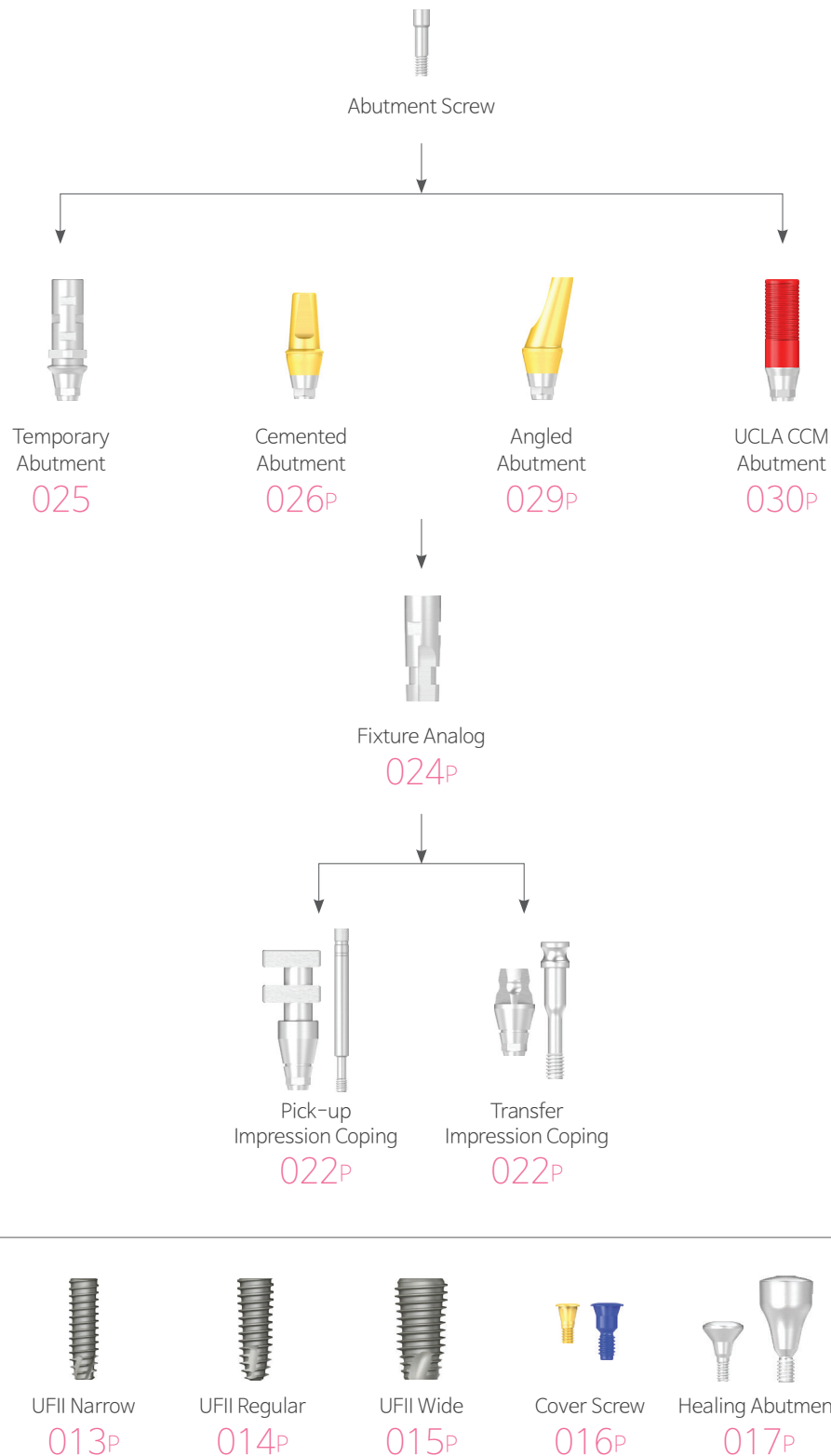

Cement / Screw – Retained Restorations

Mill / UCLA Abutment

Fixture - **R** **W**

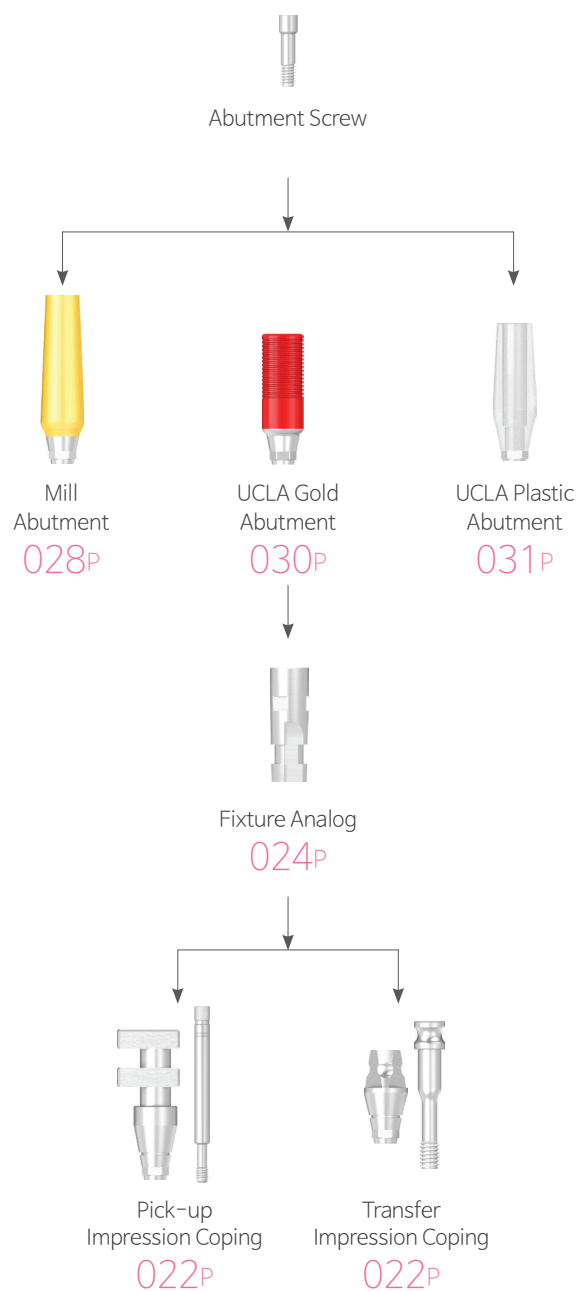

Abutment Components

Pick-up Impression Coping Hex Non-Hex

▶ Custom tray is used for pick-up type of impression taking.

- Uses 1.2 Hex Driver
- Packing Unit : Pick-up Impression Coping + Guide Pin

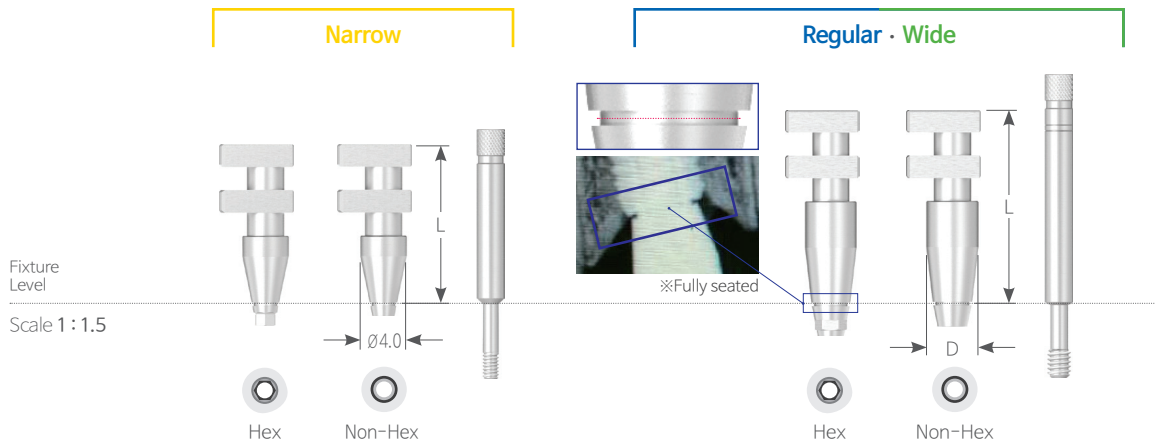

		N R W Hex						Unit mm
Fixture Size	Narrow		Regular · Wide					
Diameter	Ø4.0	Guide Pin	Ø4.0	Ø4.5	Ø5.5	Ø6.5	Guide Pin	
Length 09	-	-	SSPI 4009H	SSPI 4509H	SSPI 5509H	SSPI 6509H	SSG 2021	
12	UNSPI 4012H	UNSSG 1422	-	-	-	-	-	
13	-	-	SSPI 4013H	SSPI 4513H	SSPI 5513H	SSPI 6513H	SSG 2026	
14	UNSPI 4014H	UNSSG 1422	-	-	-	-	-	
16	UNSPI 4016H	UNSSG 1425	-	-	-	-	-	
17	-	-	SSPI 4017H	SSPI 4517H	SSPI 5517H	SSPI 6517H	SSG 2329	
19	-	-	SSPI 4019H	SSPI 4519H	SSPI 5519H	SSPI 6519H	SSG 2329	

		N R W Non-Hex						Unit mm
Fixture Size	Narrow		Regular · Wide					
Diameter	Ø4.0	Guide Pin	Ø4.0	Ø4.5	Ø5.5	Ø6.5	Guide Pin	
Length 09	-	-	SSPI 4009N	SSPI 4509N	SSPI 5509N	SSPI 6509N	SSG 2021	
12	UNSPI 4012N	UNSSG 1422	-	-	-	-	-	
13	-	-	SSPI 4013N	SSPI 4513N	SSPI 5513N	SSPI 6513N	SSG 2026	
14	UNSPI 4014N	UNSSG 1422	-	-	-	-	-	
16	UNSPI 4016N	UNSSG 1425	-	-	-	-	-	
17	-	-	SSPI 4017N	SSPI 4517N	SSPI 5517N	SSPI 6517N	SSG 2329	
19	-	-	SSPI 4019N	SSPI 4519N	SSPI 5519N	SSPI 6519N	SSG 2329	

Abutment Components

Transfer Impression Coping Hex Non-Hex

► Ready-made tray is used for transfer type of impression taking.

- Double sided structure increases quality.
- Uses 1.2 Hex Driver
- Hex type is two-piece structure and Non-Hex type is one-piece structure.
- Packing Unit : Transfer Impression Coping + Guide Pin (Hex)
Transfer Impression Coping (Non-Hex)

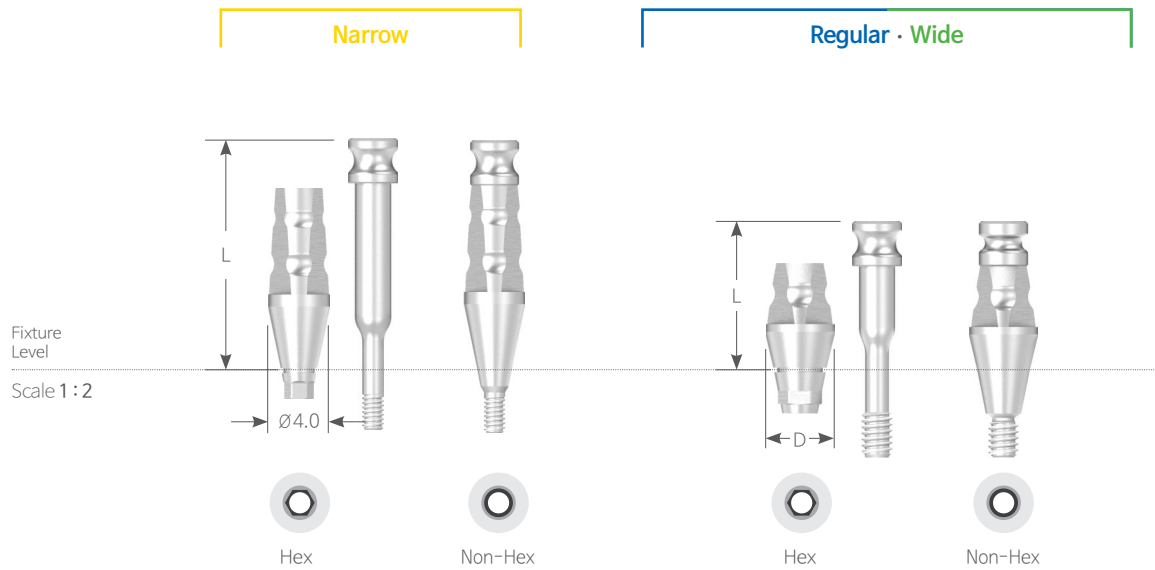

		N R W Hex							Unit mm
Fixture Size		Narrow		Regular · Wide					
Diameter		Ø4.0	Guide Pin	Ø4.0	Ø4.5	Screw	Ø5.5	Ø6.5	Guide Pin
Length 10		-	-	SSTI 4010H	SSTI 4510H	SSTI 4015S	SSTI 5510H	SSTI 6510H	SSTI 6515S
13		UNSTI 4013H	UNSTI 4013S	-	-	-	-	-	-
15		UNSTI 4015H	UNSTI 4015S	SSTI 4015H	SSTI 4515H	SSTI 4020S	SSTI 5515H	SSTI 6515H	SSTI 6520S
17		UNSTI 4017H	UNSTI 4017S	-	-	-	-	-	-

		N R W Non-Hex					Unit mm
Fixture Size		Narrow		Regular · Wide			
Diameter		Ø4.0		Ø4.0	Ø4.5	Ø5.5	Ø6.5
Length 10		-		SSTI 4010N	SSTI 4510N	SSTI 5510N	SSTI 6510N
13		UNSTI 4013N		-	-	-	-
15		UNSTI 4015N		SSTI 4015N	SSTI 4515N	SSTI 5515N	SSTI 6515N
17		UNSTI 4017N		-	-	-	-

Abutment Components

Fixture Analog

► Providing anchor point for fabricating implant prosthetics on working model.

※ Non-medical devices

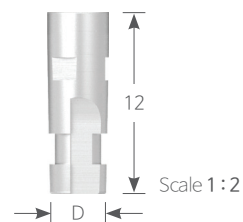

N R W Length 12

Unit mm | Scale 1:1.25

Fixture Size	Narrow	Regular · Wide
Diameter	Ø3.0	Ø4.0



UNSFA 3012



SSFA 4012

Temporary Abutment Hex Non-Hex

► Used when temporary prosthesis is made

- Hex / Non-Hex type
- Uses 1.2 Hex Driver
- Packing Unit : Abutment + Abutment Screw
- Tightening Torque : N 20Ncm, R W 30~35Ncm

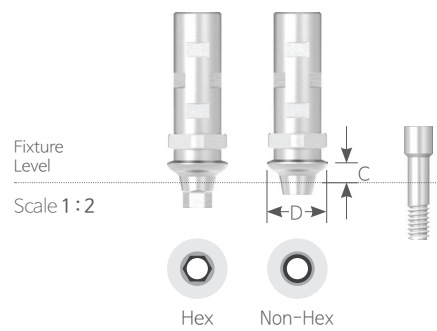

	N R W		Unit mm Scale 1 : 1.25	
Fixture Size	Narrow		Regular · Wide	
Diameter	Ø4.0		Ø4.5	
Type	Hex	Non-Hex	Hex	Non-Hex
Cuff 1	UNSTA 4010H	UNSTA 4010N	SSTA 4510H	SSTA 4510N
3	UNSTA 4030H	UNSTA 4030N	SSTA 4530H	SSTA 4530N
Abut. Screw	UNSAS 1407H	UNSAS 1407H	SSC 2008H	SSC 2008H

Cemented Abutment Hex Non-Hex

► For cement retained prosthesis

- Gold colored gingival area for esthetic purpose
- Hex / Non-Hex type
- To prevent rotation of prosthesis, it has flap section
- Uses 1.2 Hex Driver
- Compatible with Solid Abutment Impression Cap
- Packing Unit : Abutment + Abutment Screw
- Tightening Torque : **N** 20Ncm, **R W** 30~35Ncm

N R W Hex Unit mm | Scale 1 : 1.25

Fixture Size	Narrow	Regular · Wide			
Diameter	Ø4.0	Ø4.5	Ø5.5	Ø6.5	Ø7.5

Length 4					
	Cuff 1	-	SSCA 45104H(II)	SSCA 55104H(II)	SSCA 65104H(II)
2	-	SSCA 45204H(II)	SSCA 55204H(II)	SSCA 65204H(II)	SSCA 75204H(II)
3	-	SSCA 45304H(II)	SSCA 55304H(II)	SSCA 65304H(II)	SSCA 75304H(II)
4	-	SSCA 45404H(II)	SSCA 55404H(II)	SSCA 65404H(II)	SSCA 75404H(II)
5	-	SSCA 45504H(II)	SSCA 55504H(II)	SSCA 65504H(II)	SSCA 75504H(II)
Screw	-	SSC 2008SH	SSC 2008H	SSC 2008H	SSC 2008H

Length 5.5					
Cuff 1	UNSCA 40105H	SSCA 45105H(II)	SSCA 55105H(II)	SSCA 65105H(II)	SSCA 75105H(II)
2	UNSCA 40205H	SSCA 45205H(II)	SSCA 55205H(II)	SSCA 65205H(II)	SSCA 75205H(II)
3	UNSCA 40305H	SSCA 45305H(II)	SSCA 55305H(II)	SSCA 65305H(II)	SSCA 75305H(II)
4	UNSCA 40405H	SSCA 45405H(II)	SSCA 55405H(II)	SSCA 65405H(II)	SSCA 75405H(II)
5	UNSCA 40505H	SSCA 45505H(II)	SSCA 55505H(II)	SSCA 65505H(II)	SSCA 75505H(II)
6	UNSCA 40605H	-	-	-	-
7	UNSCA 40705H	-	-	-	-
Screw	UNSCAS 1407H	SSC 2008SH	SSC 2008H	SSC 2008H	SSC 2008H

Length 7					
Cuff 1	UNSCA 40107H	SSCA 45107H(II)	SSCA 55107H(II)	SSCA 65107H(II)	SSCA 75107H(II)
2	UNSCA 40207H	SSCA 45207H(II)	SSCA 55207H(II)	SSCA 65207H(II)	SSCA 75207H(II)
3	UNSCA 40307H	SSCA 45307H(II)	SSCA 55307H(II)	SSCA 65307H(II)	SSCA 75307H(II)
4	UNSCA 40407H	SSCA 45407H(II)	SSCA 55407H(II)	SSCA 65407H(II)	SSCA 75407H(II)
5	UNSCA 40507H	SSCA 45507H(II)	SSCA 55507H(II)	SSCA 65507H(II)	SSCA 75507H(II)
6	UNSCA 40607H	-	-	-	-
7	UNSCA 40707H	-	-	-	-
Screw	UNSCAS 1407H	SSC 2008SH	SSC 2008H	SSC 2008H	SSC 2008H

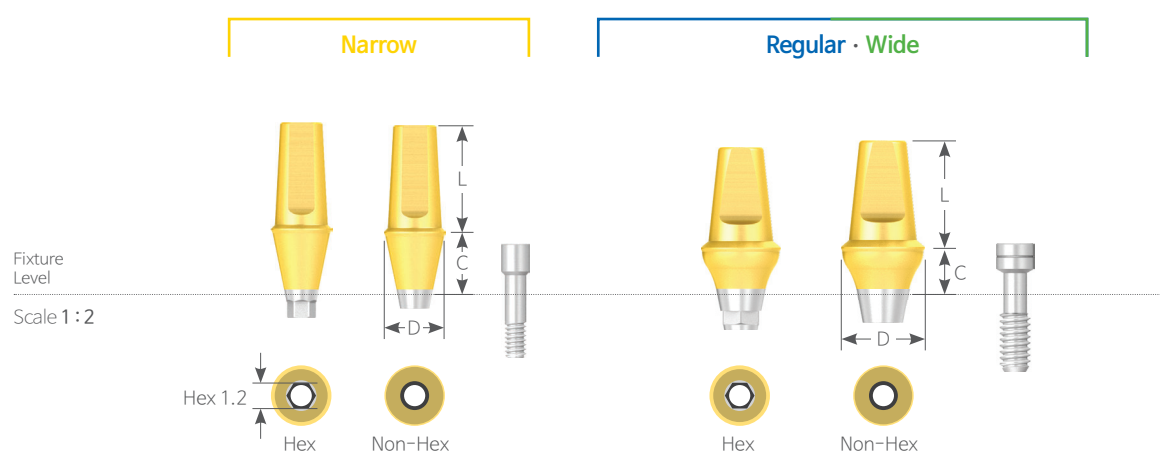

N	R	W	Non-Hex	Unit mm Scale 1:1.25	
Fixture Size	Narrow	Regular - Wide			
Diameter	Ø4.0	Ø4.5	Ø5.5	Ø6.5	Ø7.5

		Ø4.5	Ø5.5	Ø6.5	Ø7.5
Length 4					
Cuff 1	-	SSCA 45104N (II)	SSCA 55104N (II)	SSCA 65104N (II)	SSCA 75104N (II)
2	-	SSCA 45204N (II)	SSCA 55204N (II)	SSCA 65204N (II)	SSCA 75204N (II)
3	-	SSCA 45304N (II)	SSCA 55304N (II)	SSCA 65304N (II)	SSCA 75304N (II)
4	-	SSCA 45404N (II)	SSCA 55404N (II)	SSCA 65404N (II)	SSCA 75404N (II)
5	-	SSCA 45504N (II)	SSCA 55504N (II)	SSCA 65504N (II)	SSCA 75504N (II)
Screw	-	SSC 2008SH	SSC 2008H	SSC 2008H	SSC 2008H
Length 5.5					
Cuff 1	UNSCA 40105N	SSCA 45105N (II)	SSCA 55105N (II)	SSCA 65105N (II)	SSCA 75105N (II)
2	UNSCA 40205N	SSCA 45205N (II)	SSCA 55205N (II)	SSCA 65205N (II)	SSCA 75205N (II)
3	UNSCA 40305N	SSCA 45305N (II)	SSCA 55305N (II)	SSCA 65305N (II)	SSCA 75305N (II)
4	UNSCA 40405N	SSCA 45405N (II)	SSCA 55405N (II)	SSCA 65405N (II)	SSCA 75405N (II)
5	UNSCA 40505N	SSCA 45505N (II)	SSCA 55505N (II)	SSCA 65505N (II)	SSCA 75505N (II)
6	UNSCA 40605N	-	-	-	-
7	UNSCA 40705N	-	-	-	-
Screw	UNSAS 1407H	SSC 2008SH	SSC 2008H	SSC 2008H	SSC 2008H
Length 7					
Cuff 1	UNSCA 40107N	SSCA 45107N (II)	SSCA 55107N (II)	SSCA 65107N (II)	SSCA 75107N (II)
2	UNSCA 40207N	SSCA 45207N (II)	SSCA 55207N (II)	SSCA 65207N (II)	SSCA 75207N (II)
3	UNSCA 40307N	SSCA 45307N (II)	SSCA 55307N (II)	SSCA 65307N (II)	SSCA 75307N (II)
4	UNSCA 40407N	SSCA 45407N (II)	SSCA 55407N (II)	SSCA 65407N (II)	SSCA 75407N (II)
5	UNSCA 40507N	SSCA 45507N (II)	SSCA 55507N (II)	SSCA 65507N (II)	SSCA 75507N (II)
6	UNSCA 40607N	-	-	-	-
7	UNSCA 40707N	-	-	-	-
Screw	UNSAS 1407H	SSC 2008SH	SSC 2008H	SSC 2008H	SSC 2008H

Mill Abutment Hex Non-Hex

► Used for when high customization in abutment path and prosthetic margins are needed.

- Abutment of cement retained type that uses dental cement to fix prosthesis in place
- Hex / Non-Hex type
- Anti-rotational feature on abutment post.
- Uses 1.2 Hex Driver
- Packing Unit : Abutment + Abutment Screw (SSC 2008H)
- Tightening Torque : 30~35Ncm

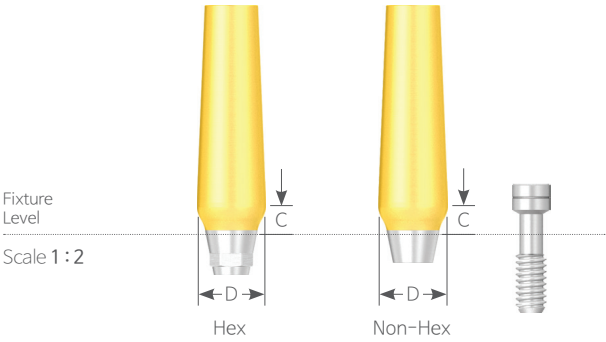

R W Hex Unit mm | Scale 1 : 1.25

Fixture Size	Regular · Wide				
Diameter	Ø4.0	Ø4.5	Ø5.5	Ø6.5	Ø7.5
Cuff	1.5	2	2.5	3	3



SSMA 4015H SSMA 4520H SSMA 5525H SSMA 6530H SSMA 7530H

R W Non-Hex Unit mm | Scale 1 : 1.25

Fixture Size	Regular · Wide				
Diameter	Ø4.0	Ø4.5	Ø5.5	Ø6.5	Ø7.5
Cuff	1.5	2	2.5	3	3



SSMA 4015N SSMA 4520N SSMA 5525N SSMA 6530N SSMA 7530N

Angled Abutment Hex Non-Hex

► Used to modify the fixture's path mainly used for anterior teeth.

- For Cement retained Type of Abutment
- Depending on the angle slope, it is categorized into 15° and 25° Angled Abutment
- Availability of A type and B type of hex part overcomes the limitation of direction of the abutment
- Gold colored gingival area for esthetic purpose
- Uses 1.2 Hex Driver
- Packing Unit : Abutment + Abutment Screw (N UNSAS 1407H, R W SSC 2008H)
- Tightening Torque : N 20Ncm, R W 30~35Ncm

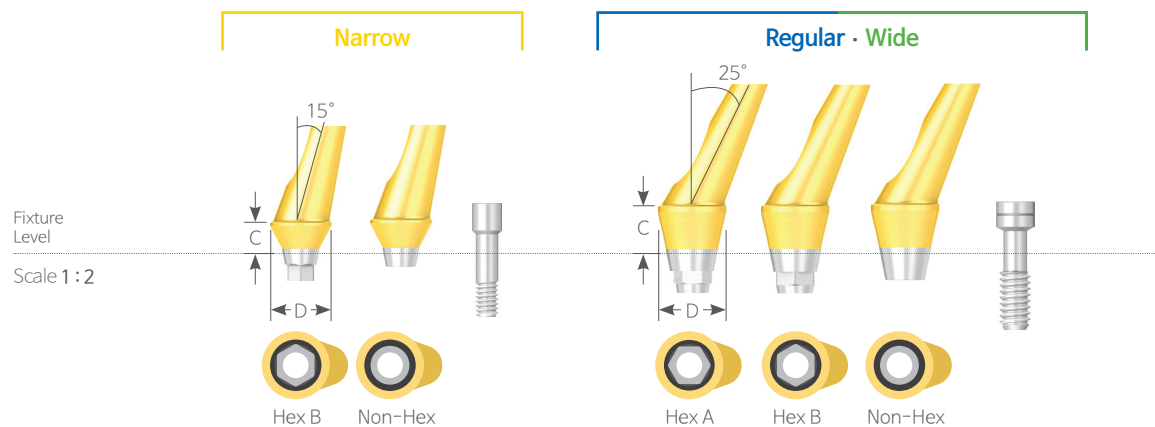

R W Hex A

Fixture Size	Narrow	Regular · Wide			
Diameter	Ø4.0	Ø4.5		Ø5.5	
Angle	15°	15°	25°	15°	25°
Cuff 1.5	-	SSAA 451515AH	SSAA 451525AH	SSAA 551515AH	SSAA 551525AH
2.0	-	SSAA 452015AH	SSAA 452025AH	SSAA 552015AH	SSAA 552025AH
3.0	-	SSAA 453015AH	SSAA 453025AH	SSAA 553015AH	SSAA 553025AH
4.0	-	SSAA 454015AH	SSAA 454025AH	SSAA 554015AH	SSAA 554025AH
5.0	-	SSAA 455015AH	SSAA 455025AH	SSAA 555015AH	SSAA 555025AH

N R W Hex B

Fixture Size	Narrow	Regular · Wide			
Cuff 1.5	-	SSAA 451515BH	SSAA 451525BH	SSAA 551515BH	SSAA 551525BH
2.0	UNSA 402015BH	SSAA 452015BH	SSAA 452025BH	SSAA 552015BH	SSAA 552025BH
3.0	-	SSAA 453015BH	SSAA 453025BH	SSAA 553015BH	SSAA 553025BH
4.0	UNSA 404015BH	SSAA 454015BH	SSAA 454025BH	SSAA 554015BH	SSAA 554025BH
5.0	-	SSAA 455015BH	SSAA 455025BH	SSAA 555015BH	SSAA 555025BH

N R W Non-Hex

Fixture Size	Narrow	Regular · Wide			
Cuff 1.5	-	SSAA 451515N	SSAA 451525N	SSAA 551515N	SSAA 551525N
2.0	UNSA 402015N	SSAA 452015N	SSAA 452025N	SSAA 552015N	SSAA 552025N
3.0	-	SSAA 453015N	SSAA 453025N	SSAA 553015N	SSAA 553025N
4.0	UNSA 404015N	SSAA 454015N	SSAA 454025N	SSAA 554015N	SSAA 554025N
5.0	-	SSAA 455015N	SSAA 455025N	SSAA 555015N	SSAA 555025N

UCLA Abutment

UCLA Gold Abutment Hex Non-Hex

► Can be used when there is limitation on path, esthetics, space etc.

- For screw retained prosthesis
- Directly casted on abutment to make inner part of prosthesis
- Customized abutment can be made which can be applied to variety of cases.
- Strong enough for cases requiring difficult angle modification.
- After the customization, **dental gold alloy will be casted only.**
- Melting range on cylinder area : 1400~1450°C
(Do not use with non-precious metal alloy)
- Hex / Non-Hex type · Uses 1.2 Hex Driver
- Packing Unit : Abutment + Abutment Screw (SSC 2008H)
- Tightening Torque : 30~35Ncm

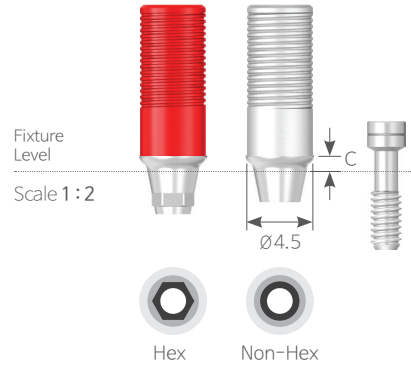

R W D $\varnothing 4.5$	Unit mm Scale 1 : 1.25	
Fixture Size	Regular · Wide	
Type	Hex	Non-Hex

		
Cuff 1	SSGA 4510H	SSGA 4510N
3	SSGA 4530H	SSGA 4530N

UCLA CCM Abutment Hex Non-Hex

- After the customization, **non-precious metal alloy will be casted only.**
- Hex / Non-Hex type
- Uses 1.2 Hex Driver
- Packing Unit : Abutment + Abutment Screw (**N** UNSAS 1407H, **R** **W** SSC 2008H)
- Tightening Torque : 30~35Ncm
- ※ Non-medical devices

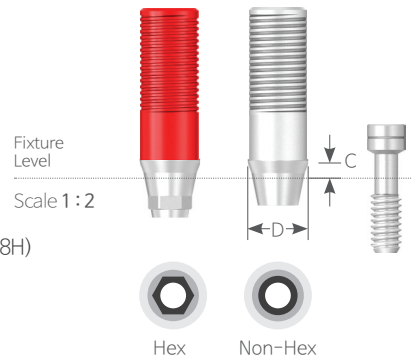

N R W	Unit mm Scale 1 : 1.25					
Fixture Size	Narrow		Regular · Wide			
Diameter	$\varnothing 4.0$	$\varnothing 4.0$	$\varnothing 4.0$	$\varnothing 4.0$	$\varnothing 4.5$	$\varnothing 4.5$
Hex	Hex	Non-Hex	Hex	Non-Hex	Hex	Non-Hex

						
Cuff 1	UNSCCA 4010H	UNSCCA 4010N	CCSS 4010H[H]	CCSS 4010N[H]	CCSS 4510H[H]	CCSS 4510N[H]
3	UNSCCA 4030H	UNSCCA 4030N	-	-	CCSS 4530H[H]	CCSS 4530N[H]

UCLA Plastic Abutment Hex Non-Hex

- Less accuracy on connecting part compared to UCLA Gold Abutment.
- After the customization, **non-precious metal alloy will be casted only.**
- Be careful about fracture if deleted
- Hex / Non-Hex type
- Uses 1.2 Hex Driver
- Packing Unit : Abutment + Abutment Screw (SSC2008H)
- Tightening Torque : Tightening smoothly before casting,
30~35Ncm after casting

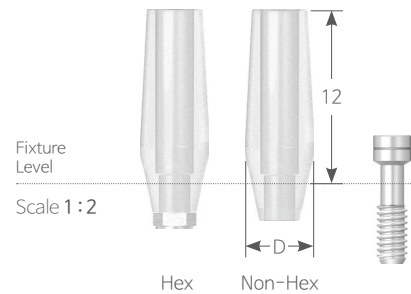

R W Length 12

Unit mm | Scale 1 : 1.25

Fixture Size	Regular · Wide			
Diameter	Ø4.5	Ø4.5	Ø5.5	Ø5.5
Type	Hex	Non-Hex	Hex	Non-Hex



SSPA 4512H



SSPA 4512N



SSPA 5512H



SSPA 5512N

Cement-Retained Restorations

Solid Abutment

Fixture - **N R W**



Plastic Coping

035P



Solid Abutment Analog

035P



Impression Cap

034P



Solid Abutment

033P



Protect Cap

034P



UFII Narrow

013P



UFII Regular

014P



UFII Wide

015P



Cover Screw

016P



Healing Abutment

017P

Solid Abutment

► Abutment of cement retained type that uses dental cement to fix prosthesis in place

- Abutment and screw are in one-piece structure.
- Taking impression at abutment level.
- Gold colored gingival area for esthetic purpose
- Uses 1.2 Hex Driver / Solid Abutment Driver
- Packing Unit : Abutment + Protect Cap
- Tightening Torque : **N** 20Ncm, **R W** 30~35Ncm

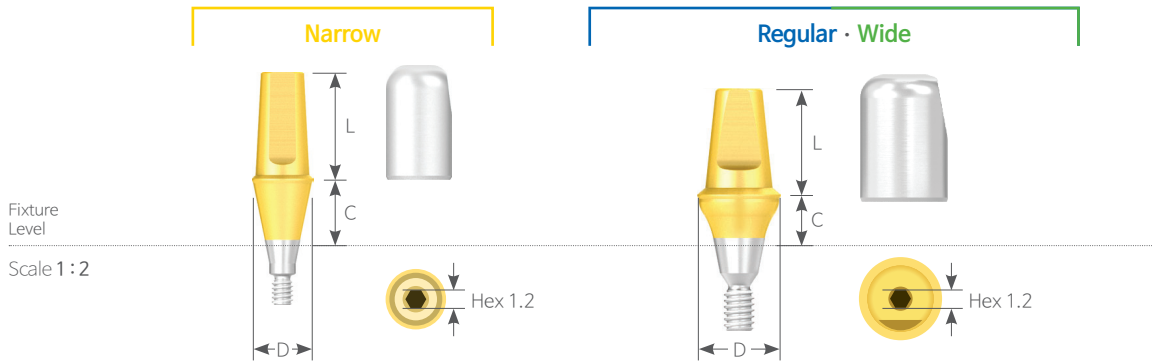

N R W

Unit mm | Scale 1 : 1.25

Fixture Size	Narrow	Regular · Wide			
Abut. Diameter	Ø4.0	Ø4.5	Ø5.5	Ø6.5	Ø7.5



Abut. Length 4 Cuff 1	-	SSSA 45104	SSSA 55104	SSSA 65104	SSSA 75104
2	-	SSSA 45204	SSSA 55204	SSSA 65204	SSSA 75204
3	-	SSSA 45304	SSSA 55304	SSSA 65304	SSSA 75304
4	-	SSSA 45404	SSSA 55404	SSSA 65404	SSSA 75404
5	-	SSSA 45504	SSSA 55504	SSSA 65504	SSSA 75504

Abut. Length 5.5 Cuff 1	UNSSA 40105	SSSA 45105	SSSA 55105	SSSA 65105	SSSA 75105
2	UNSSA 40205	SSSA 45205	SSSA 55205	SSSA 65205	SSSA 75205
3	UNSSA 40305	SSSA 45305	SSSA 55305	SSSA 65305	SSSA 75305
4	UNSSA 40405	SSSA 45405	SSSA 55405	SSSA 65405	SSSA 75405
5	UNSSA 40505	SSSA 45505	SSSA 55505	SSSA 65505	SSSA 75505
6	UNSSA 40605	-	-	-	-
7	UNSSA 40705	-	-	-	-

Abut. Length 7 Cuff 1	UNSSA 40107	SSSA 45107	SSSA 55107	SSSA 65107	SSSA 75107
2	UNSSA 40207	SSSA 45207	SSSA 55207	SSSA 65207	SSSA 75207
3	UNSSA 40307	SSSA 45307	SSSA 55307	SSSA 65307	SSSA 75307
4	UNSSA 40407	SSSA 45407	SSSA 55407	SSSA 65407	SSSA 75407
5	UNSSA 40507	SSSA 45507	SSSA 55507	SSSA 65507	SSSA 75507
6	UNSSA 40607	-	-	-	-
7	UNSSA 40707	-	-	-	-

Solid Abutment Components

Protect Cap

► Used to protect abutment in the patient's mouth and minimize the discomfort for the patient.

- Can be applied to substructure of temporary prosthesis.
- Convenient locking mechanism.



		N	R	W		
Fixture Size		Narrow			Regular · Wide	
Abut. Diameter		Ø4.0	Ø4.5	Ø5.5	Ø6.5	Ø7.5
Abut. Length 4		-	SSAC 4504	SSAC 5504	SSAC 6504	SSAC 7504
5.5		UNSAI 4005	SSAC 4505	SSAC 5505	SSAC 6505	SSAC 7505
7		UNSAI 4007	SSAC 4507	SSAC 5507	SSAC 6507	SSAC 7507

Unit mm | Scale 1:2

Impression Cap

► Used for taking impression of Solid Abutment.

- Different coloring provides easy identification for abutment diameter.
- Convenient locking mechanism.

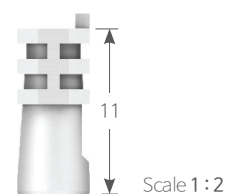

		N	R	W	Length 11	
Fixture Size		Narrow			Regular · Wide	
Abut. Diameter		Ø4.0	Ø4.5	Ø5.5	Ø6.5	Ø7.5

Unit mm | Scale 1:1.25



UNSAI 4011

SSAI 4511

SSAI 5511

SSAI 6511

SSAI 7511

Solid Abutment Analog

- Solid Abutment is formed on working model.
- Different coloring provides easy identification for abutment diameter.



Scale 1 : 2

	N	R	W		
Fixture Size	Narrow		Regular · Wide		
Abut. Diameter	Ø4.0	Ø4.5	Ø5.5	Ø6.5	Ø7.5

Unit mm | Scale 1 : 1.25



Abut. Length 4	-	SSAA 4504	SSAA 5504	SSAA 6504	SSAA 7504
5.5	UNSSAA 4005	SSAA 4505	SSAA 5505	SSAA 6505	SSAA 7505
7	UNSSAA 4007	SSAA 4507	SSAA 5507	SSAA 6507	SSAA 7507

Plastic Coping

- ▶ Can be used as prosthesis' frame work by installing Solid Fixture Analog.
- Different coloring provides easy identification on types of case.

Narrow

Regular · Wide



Single

Bridge



Single

Bridge

	N	R	W	Length 10	
Fixture Size	Narrow		Regular · Wide		
Abut. Diameter	Ø4.0	Ø4.5	Ø5.5	Ø6.5	Ø7.5

Unit mm | Scale 1 : 2

● Single	UNSAF 4010S	SSAF 4510S	SSAF 5510S	SSAF 6510S	SSAF 7510S
○ Bridge	UNSAF 4010B	SSAF 4510B	SSAF 5510B	SSAF 6510B	SSAF 7510B

Screw-Retained Restorations

Octa Abutment

Fixture - **R** **W**

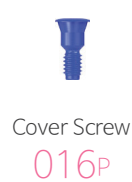
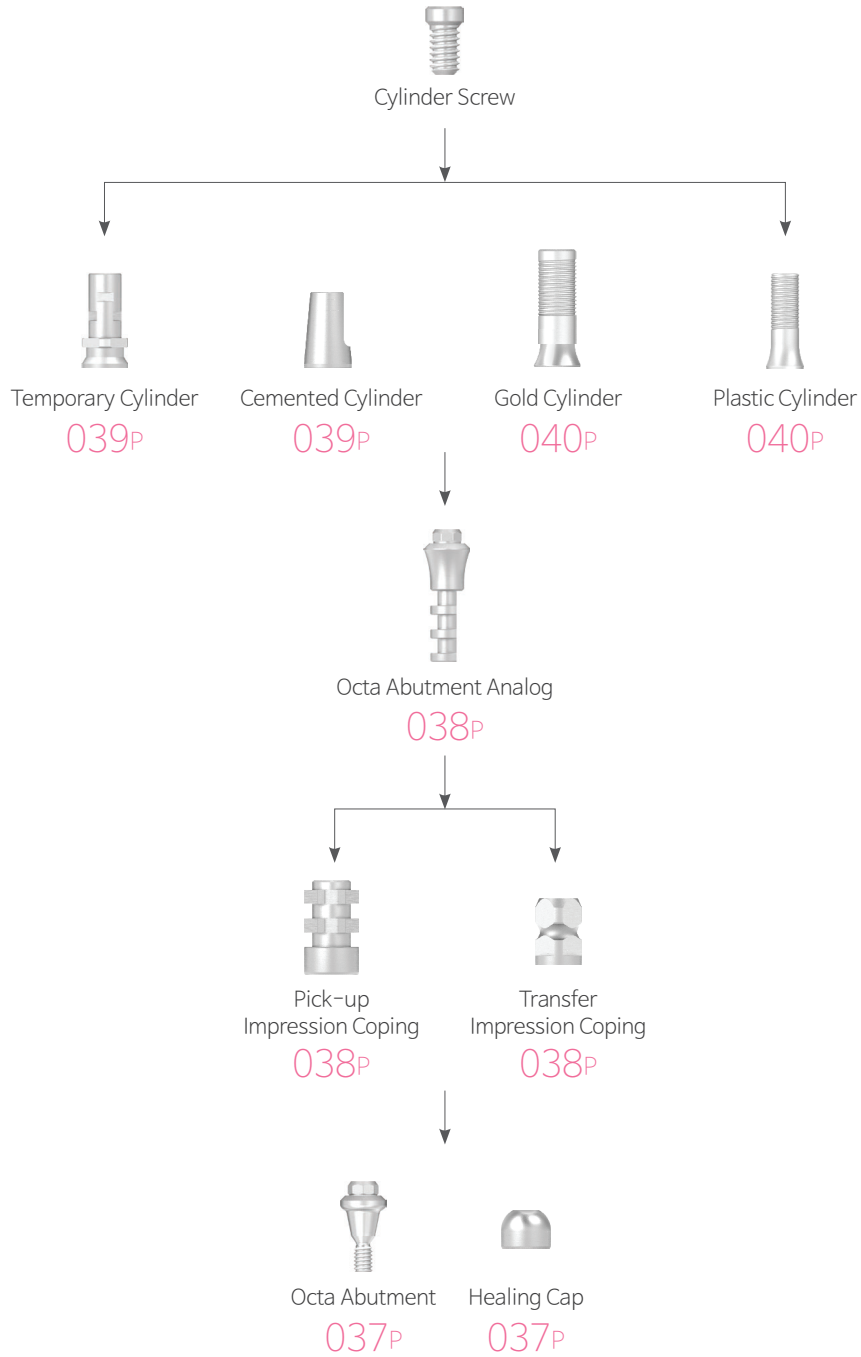

Octa Abutment

► Used to create screw retained prosthesis on poor path bridge case.

- Convert internal connection to external connection, and then use cylinder on it for prosthesis.
- Uses Octa Abutment Driver (HD 3006A-Short / HD 3012A-Long)
- Packing Unit : Octa Abutment + Abutment Holder (Convenient to install in patient's Mouth.)
- Tightening Torque : 30~35Ncm

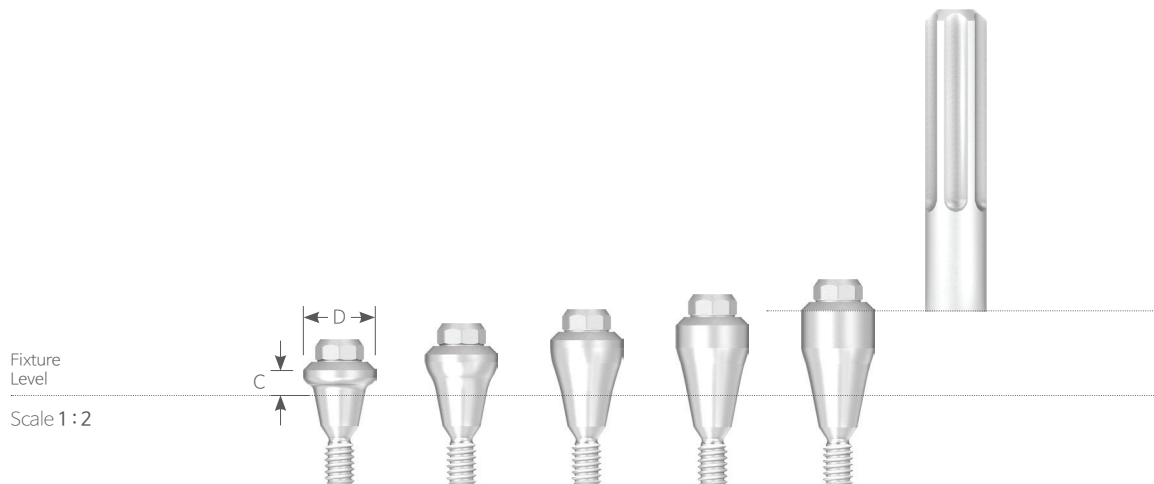

R W		Unit mm Scale 1:2		
Fixture Size	Regular · Wide			
Diameter	Ø4.8	Ø6.0	Ø6.5	
Cuff 1.5	SSOA 4815	SSOA 6015	SSOA 6515	
2.5	SSOA 4825	SSOA 6025	SSOA 6525	
3.5	SSOA 4835	SSOA 6035	SSOA 6535	
4.5	SSOA 4845	SSOA 6045	SSOA 6545	
5.5	SSOA 4855	SSOA 6055	SSOA 6555	

Healing Cap

► To protect Octa Abutment in oral, and minimize the discomfort for patient.

- Uses 1.2 Hex Driver
- Packing Unit : Healing Cap + Cylinder Screw (STI 2004H)
- Tightening Torque : 20Ncm



R W		Unit mm Scale 1:2		
Fixture Size	Regular · Wide			
Abut. Diameter	Ø4.8	Ø6.0	Ø6.5	
	HCI 48504	HCI 60704	HCI 65704	

Octa Abutment Components

Pick-up Impression Coping Octa Non-Octa

- ▶ Custom tray is used for pick-up type of impression taking.
- Asymmetry structure to minimize close interruption
- Uses 1.2 Hex Driver
- Packing Unit : Pick-up Impression Coping + Guide Pin (POI 2610)

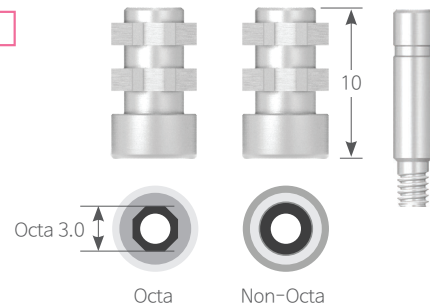

R W Length 10 Unit mm | Scale 1:2

Fixture Size	Regular · Wide		
Abut. Diameter	Ø4.8	Ø6.0	Ø6.5
Octa	IPI 48610	IPI 60710	IPI 65710
Non-Octa	IPI 48610N	IPI 60710N	IPI 65710N

Transfer Impression Coping

- ▶ Ready-made tray is used for transfer type of impression taking.
- Double sided structure which elevates the quality
- Uses 1.2 Hex Driver
- Packing Unit : Transfer Impression Coping + Coping Screw (IOTI 48010S)

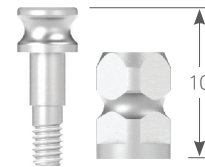

R W Length 10 Unit mm | Scale 1:2

Fixture Size	Regular · Wide		
Abut. Diameter	Ø4.8	Ø6.0	Ø6.5
	IOTI 48010	IOTI 60010	IOTI 65010

Octa Abutment Analog

- ▶ Octa Abutment is formed on working model.
- ※ Non-medical devices



R W Unit mm | Scale 1:2

Fixture Size	Regular · Wide		
Abut. Diameter	Ø4.8	Ø6.0	Ø6.5
Length 10	-	RCI 60014	-
12	RCI 48014	-	RCI 65014

Temporary Cylinder Octa Non-Octa

- Uses 1.2 Hex Driver
- Packing Unit : Temporary Cylinder + Cylinder Screw (STI 2004H)
- Tightening Torque : 20Ncm

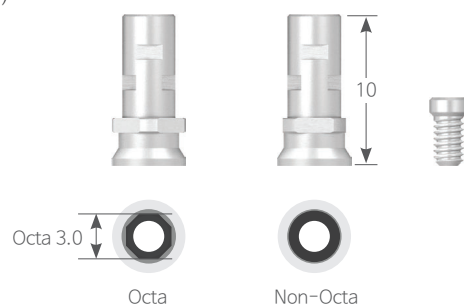

Fixture Size	Regular · Wide		
Abut. Diameter	Ø4.8	Ø6.0	Ø6.5
Octa	ITC 48010	ITC 60010	ITC 65010
Non-Octa	ITC 48010N	ITC 60010N	ITC 65010N

Cemented Cylinder Octa Non-Octa

- Uses 1.2 Hex Driver
- Packing Unit : Cemented Cylinder + Cylinder Screw (STI 2004H)
- Tightening Torque : 20Ncm

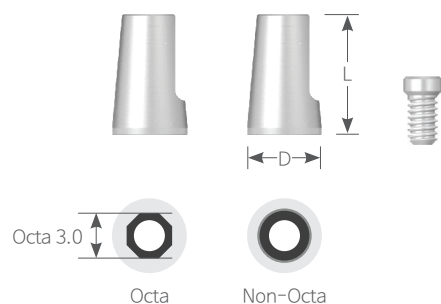

Fixture Size	Regular · Wide			
Abut. Diameter	Ø4.8	Ø4.8	Ø6.0	Ø6.5
Cylinder Diameter	Ø5.0	Ø5.8	Ø6.4	Ø6.9
Length	8	8	9	9
Octa	ICC 48508 [H]	ICC 48588 [H]	ICC 60649 [H]	ICC 65309 [H]
Non-Octa	ICC 48508N [H]	ICC 48588N [H]	ICC 60649N [H]	ICC 65309N [H]

Octa Abutment Components

Gold Cylinder Octa Non-Octa

- After the customization, **dental gold alloy will be casted only.**
- Cylinder fusion range: 1400°C~1450°C
(Do not use with non-precious metal alloy)
- Uses 1.2 Hex Driver
- Packing Unit : Gold Cylinder + Cylinder Screw (STI 2004H)
- Tightening Torque : 20Ncm

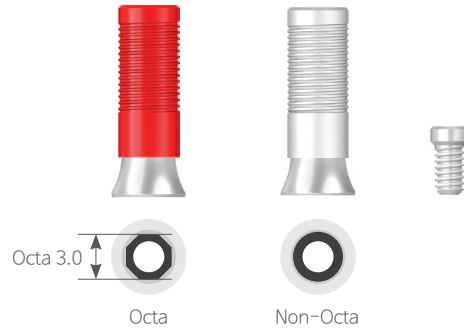

R W		Unit mm Scale 1:2		
Fixture Size	Regular · Wide			
Abut. Diameter	Ø4.8	Ø6.0	Ø6.5	
Octa ●	AGI 48504 [H]	AGI 60004 [H]	AGI 65704 [H]	
Non-Octa ○	AGI 48504N [H]	AGI 60004N [H]	AGI 65704N [H]	

Plastic Cylinder Octa Non-Octa

- After the customization, **non-precious metal alloy will be casted only.**
- Less accuracy on connecting part compared to Gold Cylinder.
- Uses 1.2 Hex Driver
- Packing Unit : Plastic Cylinder + Cylinder Screw (STI 2004H)
- Tightening Torque : 20Ncm
- ※ Non-medical devices



R W		Unit mm Scale 1:2		
Fixture Size	Regular · Wide			
Abut. Diameter	Ø4.8	Ø6.0	Ø6.5	
Octa ●	API 48514 [H]	API 60714 [H]	API 65714 [H]	
Non-Octa ○	API 48514N [H]	API 60714N [H]	API 65714N [H]	

Overdenture-Retained Restorations

Ball Abutment

Fixture - **R** **W**



Overdenture-Retained Restorations

Ball Abutment / Locator

Fixture - **N R W**



Stainless Steel Housing

045P



OT Cap



Ball Abutment Analog

044P



Ball Abutment

043P



UFII Narrow

013P



UFII Regular

014P



UFII Wide

015P



Cover Screw

016P



Healing Abutment

017P

Ball Abutment

- ▶ Used to create over-denture for edentulous patient.
- ▶ Used when fixed type prosthesis is difficult due to severe bone or soft tissue loss.
- Composition of o-ring: For dental lab use (black), for clinic use (orange)
- Post partis coloring in gold
- Path recovery to the maximum of 20°
- Uses Ball Abutment Driver
- Packing Unit :
Ball Abutment + Abutment Holder (Convenient to install in patient's mouth) + O-Ring (Orange : For clinic use)
- Tightening Torque : **N** 20Ncm, **R W** 30~35Ncm

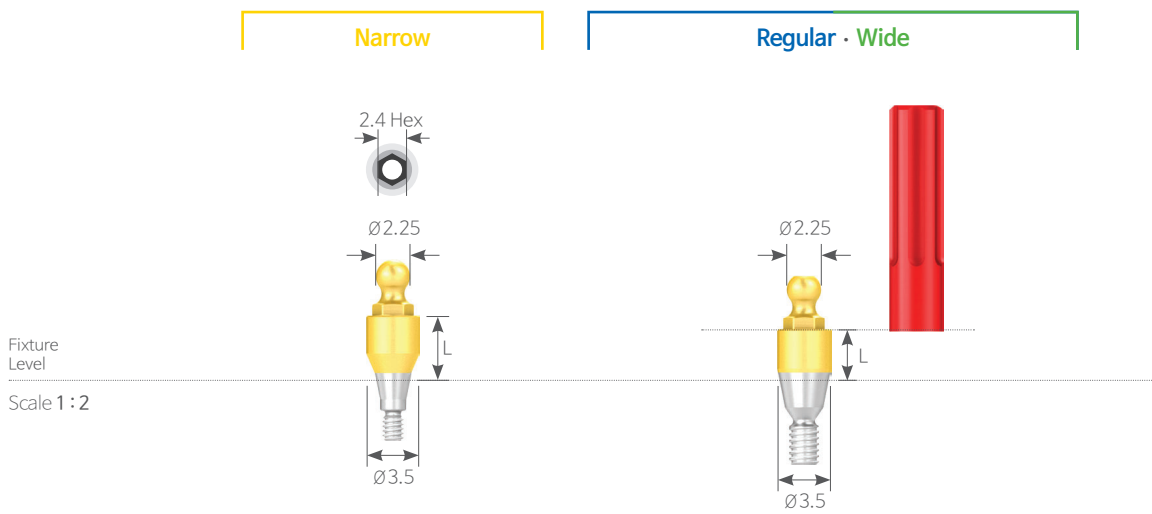

	N	R	W	
Fixture Size	Narrow		Regular · Wide	
Diameter	Ø3.5		Ø3.5	
Length 1	UNSBA 3510		SSBA 3510	
2	UNSBA 3520		SSBA 3520	
3	UNSBA 3530		SSBA 3530	
4	UNSBA 3540		SSBA 3540	
5	UNSBA 3550		SSBA 3550	
6	UNSBA 3560		SSBA 3560	
7	UNSBA 3570		-	

Unit mm

Ball Abutment Components

Ball Abutment Analog

► Provides anchor point for ball abutment on working model.

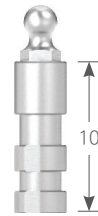

N R W Length 10 Unit mm | Scale 1:2

Fixture Size	Narrow	Regular · Wide
Abut. Diameter	Ø3.5	Ø3.5
	UNSBAA 3510	SABA 3510

Retainer

- Advantageous when occlusal distance is low compare to Ball Cap.
- Packing Unit : Retainer + O-Ring (OR 0450B / OR 04500)

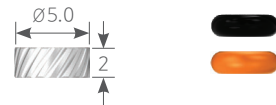

N R W D Ø5.0 Length 2 Unit mm | Scale 1:2

Fixture Size	Narrow · Regular · Wide
	RT 0502

Ball Cap

- Outstanding consistency and clip-on
- Packing Unit : Ball Cap + O-Ring (OR 0450B / OR 04500)

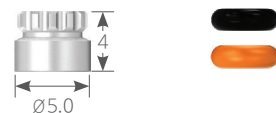

N R W D Ø5.0 Length 4 Unit mm | Scale 1:2

Fixture Size	Narrow · Regular · Wide
	BC 5004

O-Ring

- Black : For dental lab use
- Orange : For clinic use (Over 6Ncm)
- Packing Unit : O-Ring 1 Piece

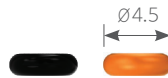

N R W D Ø4.5 Unit mm | Scale 1 : 2

Fixture Size	Narrow · Regular · Wide	
Color	OR 0450B ● Black	OR 04500 ● Orange

Stainless Steel Housing

- The new stainless steel housing decrease the size that can provide better stability and retention with resin.
- Packing Unit : 2 Pieces



N R W D Ø4.6 Length 3 Unit mm | Scale 1 : 2

Fixture Size	Narrow · Regular · Wide	
	041CAN	

Screw-Retained Restorations

Multiunit Abutment

Fixture - **R** **W**

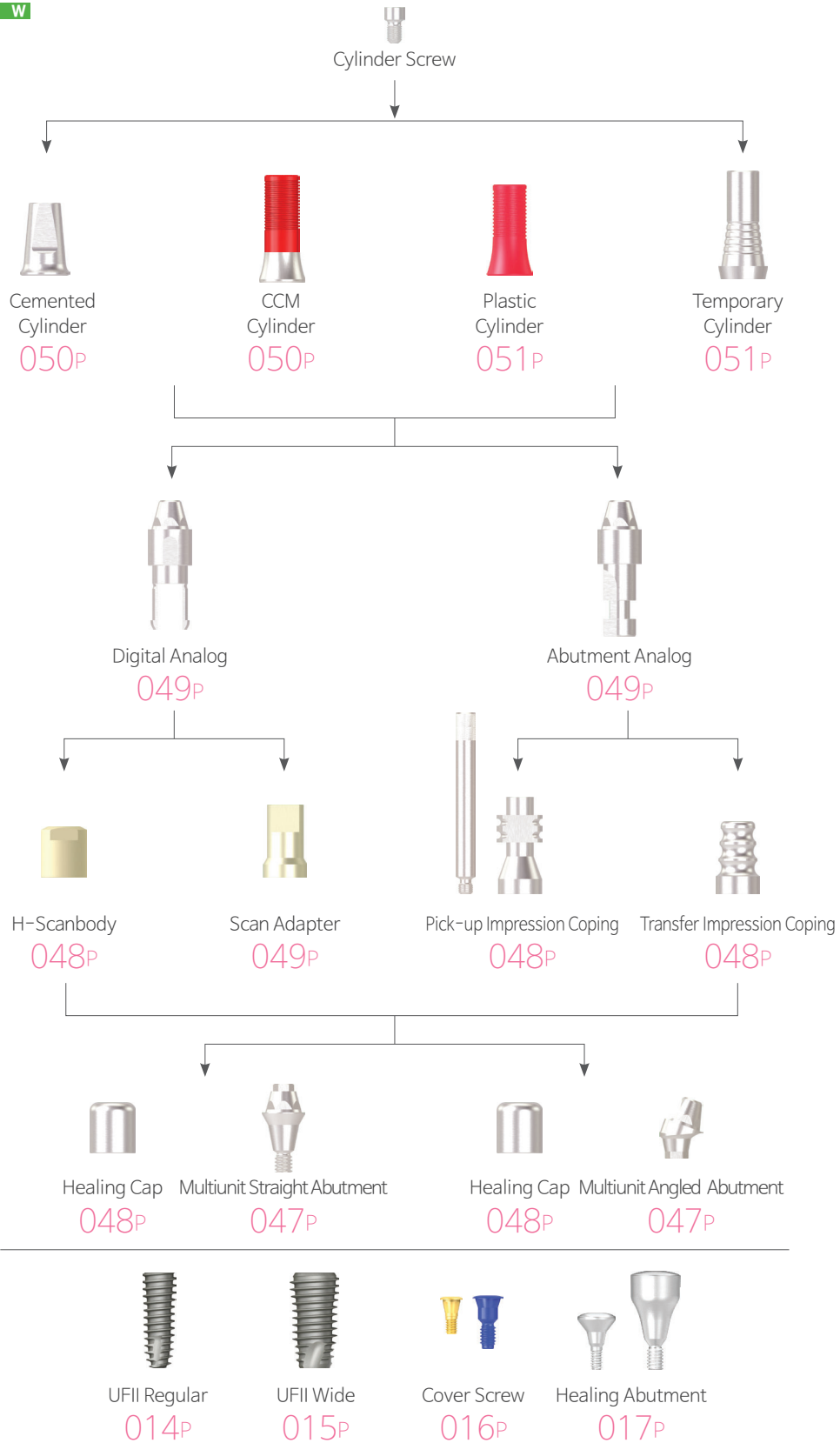

Multiunit Straight Abutment

► Use it to fabricate a screw-retained prosthesis in a bridge case with different path.

- Screw-Retained type
- Tightening Torque : 30Ncm
- Packing unit : Multiunit Straight Abutment + Holder
- Use Ø2.0 Multiunit Straight Abutment Driver (HD 2012A)



R	W	D	Ø4.8	Hex 2.0	Unit mm
Cuff		1.5	2.5	3.5	4.5
		MSA 4801	MSA 4802	MSA 4803	MSA 4804

Multiunit Angled Abutment

- Screw Retained type (Post Hex type)
- Multiunit Angled Abutment and Fixture (UFII Regular/Wide) are fastened with the Multiunit Angled Abutment Screw (MASC 2006).
- Multiunit Angled Abutment is is path compensate Maximum up to 60°
- Tightening Torque : 30Ncm
- Packing unit : Multiunit Angled Abutment + Screw + Holder
- Use Multiunit Angled Abutment Driver : MHD 1215A (Ratchet) / MMD 1224 (Machine)



R	W	D	Ø4.8	Hex	Unit mm
Angle				20°	30°
Cuff 2.5				MAA 482520H	
3.5				MAA 483520H	MAA 483530H
4.5				MAA 484520H	MAA 484530H
5.5				MAA 485520H	MAA 485530H

Multiunit Abutment Components

Healing Cap

- To protect Abutment and minimize the discomfort in the patient's mouth
- Uses 1.2 Hex Driver
- Tightening Torque : 5~8Ncm

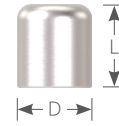

Unit mm | Scale 1:2

R W D Ø5.0 Length 5.5

Code	MHC 5005
------	----------

Pick-up Impression Coping

- Pick-up type Impression Coping to take an abutment level impression.
- Used with an open tray
- Only for Multiunit Abutment
- Uses 1.2 Hex Driver
- Packing Unit : Pick-up Impression Coping + Guide Pin (MGP 1615)
- Tightening Torque : 5~8Ncm

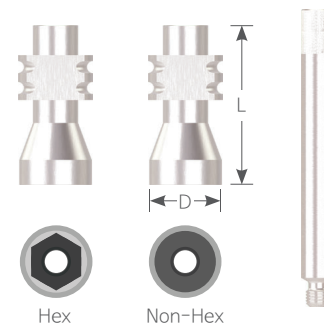

Unit mm | Scale 1:2

R W D Ø4.8 Length 17

Type	Hex	Non Hex
	MPI 4811H	MPI 4811N

Transfer Impression Coping

- Transfer type Impression Coping to take an abutment level impression.
- Used with Closed Tray
- Only for Multiunit Abutment
- Uses 1.2 Hex Driver
- Tightening Torque : 5~8Ncm



Unit mm | Scale 1:2

R W D Ø4.8 Length 8

Code	MTI 4808N
------	-----------

H-Scan body

- Healing Abutment function
- Use for digital Impression taking
- Uses 1.2 Hex Driver
- Packing Unit : H-Scan body + Screw (MHSBSC 1603)
- Tightening Torque : 5~8Ncm

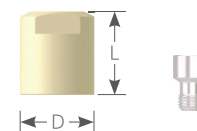

Unit mm | Scale 1:2

R W D Ø5.0 Length 5.6

Code	MHSB 5005H
------	------------

Scan Adapter

- Use for digital Impression taking
- Uses 1.2 Hex Driver
- Packing Unit : Scan Adapter + Screw(MCSC 1606)
- Tightening Torque : 5~8Ncm

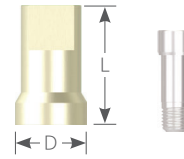

R W D Ø4.8 Length **8**

Unit mm | Scale 1 : 2

Code	MSCAN 4808H
------	-------------

Abutment Analog

- Usage for laboratory fabricated Abutment level cast model

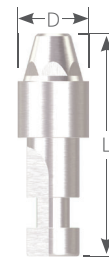

R W D Ø4.8 Length **15**

Unit mm | Scale 1 : 2

Code	MLA 4815H
------	-----------

Digital Analog

- Usage for 3D Printing Model

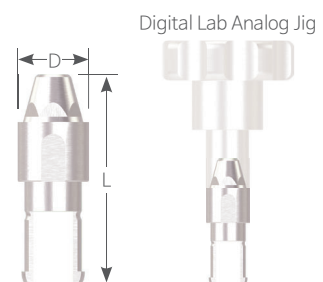

R W D Ø4.8 Length **14.2**

Unit mm | Scale 1 : 2

Code	MDA 4813
------	----------

Multiunit Abutment Components

CCM Cylinder Hex Non-Hex

- Used to fabricate prosthesis on the abutment level with casting with non-precious metal alloys.
- Color Type : Hex type (Red), Non-Hex type (White)
- CCM fusion range : 1380°C ~ 1420°C
- Uses 1.2 Hex Driver
- Packing Unit : CCM Cylinder + Screw (MSC 1604)
- Tightening Torque : 20Ncm

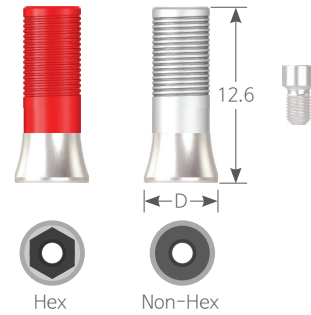

R **W** **D** Ø5.0 Length 12.6

Unit mm | Scale 1:2

Type	Hex	Non Hex
	MCCM 5005H	MCCM 5005N

Cemented Cylinder Hex Non-Hex

- Used to fabricate cement-retained prosthesis on the abutment level.
- Uses 1.2 Hex Driver
- Packing Unit : Cemented Cylinder + Screw (MSC 1604)
- Tightening Torque : 20Ncm

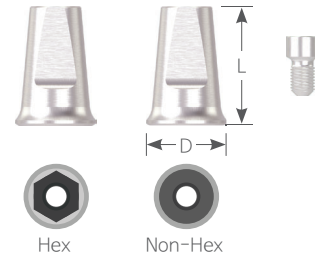

R **W** **D** Ø5.4 Length 8

Unit mm | Scale 1:2

Type	Hex	Non Hex
	MCEM 5408H	MCEM 5408N

Plastic Cylinder Hex Non-Hex

- Used to fabricate prosthesis on the abutment level with casting with non-precious metal alloys.
- Color Type : Hex type (Red), Non-Hex type (White)
- Uses 1.2 Hex Driver
- Packing Unit : Plastic Cylinder + Screw (MSC 1604)
- Tightening Torque : 20Ncm



R **W** **D** Ø5.0 Length 10

Unit mm | Scale 1:2

Type	Hex	Non Hex
	MPLA 5010H	MPLA 5010N

Temporary Cylinder Hex Non-Hex

- Used to Temporary prosthesis on the abutment level.
- Uses 1.2 Hex Driver
- Packing Unit : Temporary Cylinder+ Screw(MSC 1604)
- Tightening Torque : 20Ncm

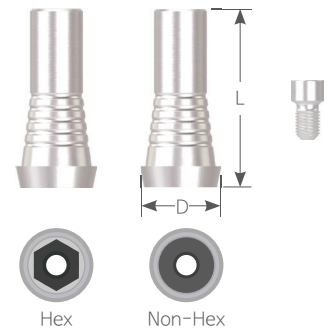

R W D Ø5.4 Length 12	Unit mm Scale 1 : 2	
Type	Hex	Non Hex
Code	MTEM 5412H	MTEM 5412N

Cylinder Screw



R W Length 4	Unit mm Scale 1 : 2
Code	MSC 1604

Surgical Tool

Screw Driver

- Only use Multiunit Abutment

● Sold separately

K Hex 1.2	Unit mm Scale 1 : 1	
Type	Machine	Ratchet
Code	MMD 1224	MHD 1215A



UFII Master Kit Kit Code | UF(M) 06

· Kit composed of drill with outstanding cutting force and durability, etc.
 · UFII Narrow $\varnothing 3.0$ $\varnothing 3.3$ / UFII Regular $\varnothing 3.8$ $\varnothing 4.0$ $\varnothing 4.5$ $\varnothing 5.0$ Fixture

Unit mm | Drill Scale 1 : 0.9

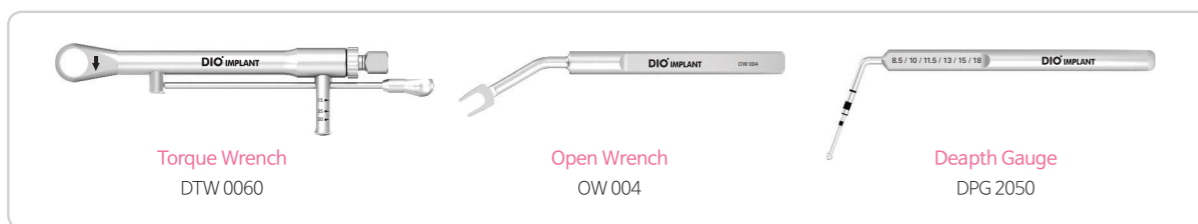
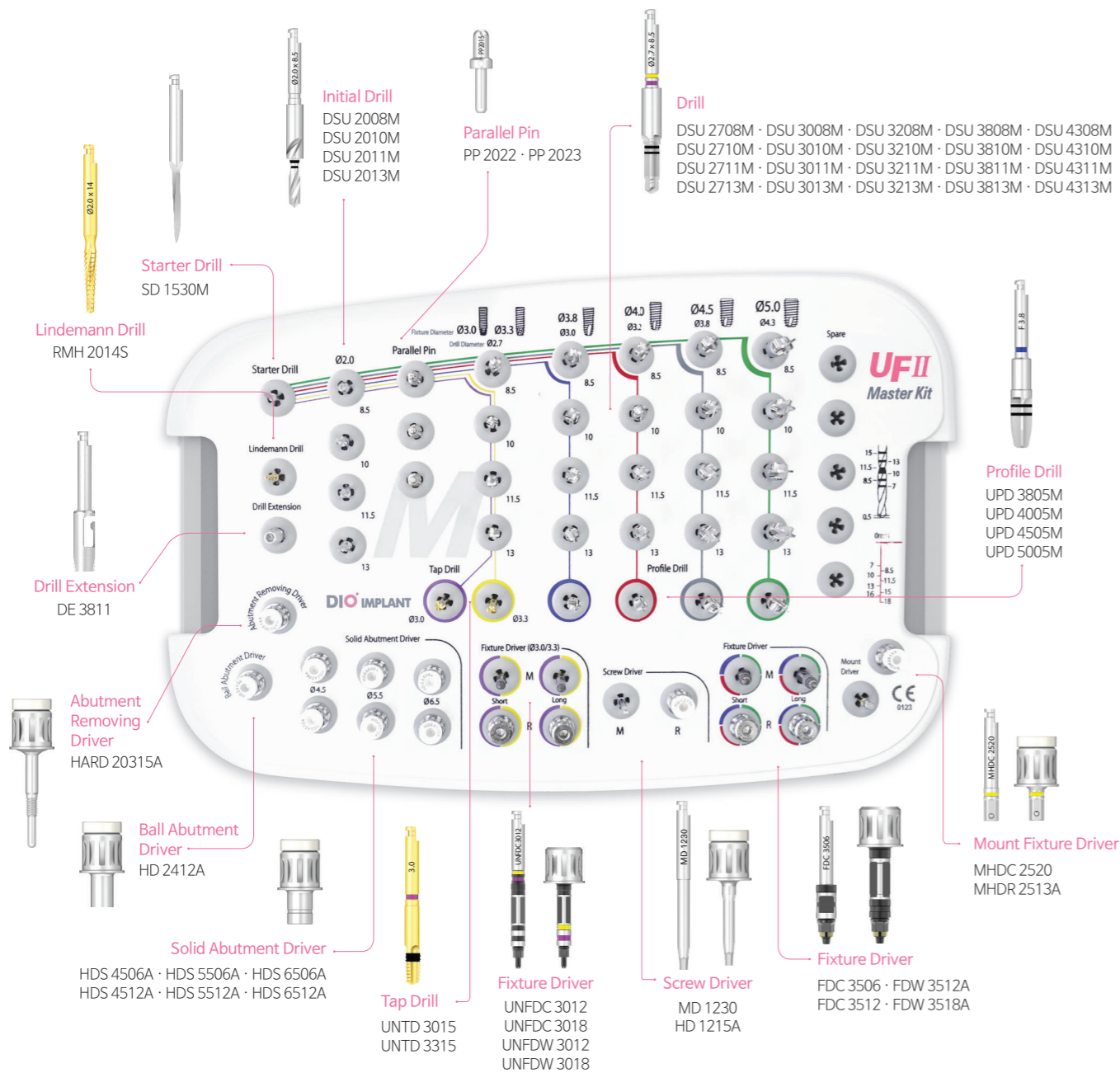

Ver A

UFII Surgical Kit Kit Code | UF(M) 07

· Kit composed of drill with outstanding cutting force and durability, etc.
 · UFII Narrow $\varnothing 3.0$ $\varnothing 3.3$ / UFII Regular $\varnothing 3.8$ $\varnothing 4.0$ $\varnothing 4.5$ $\varnothing 5.0$ $\varnothing 5.5$ Fixture

Unit mm | Drill Scale 1 : 0.9

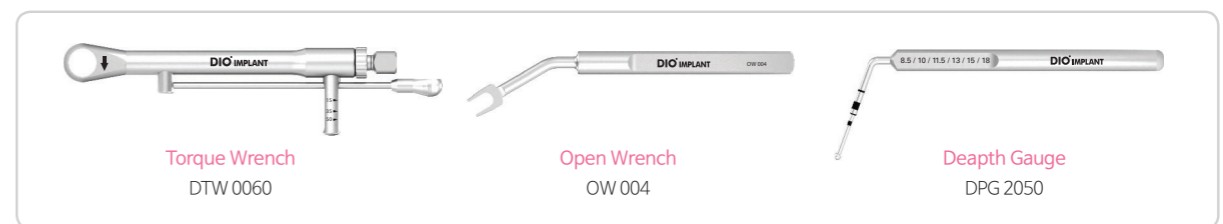
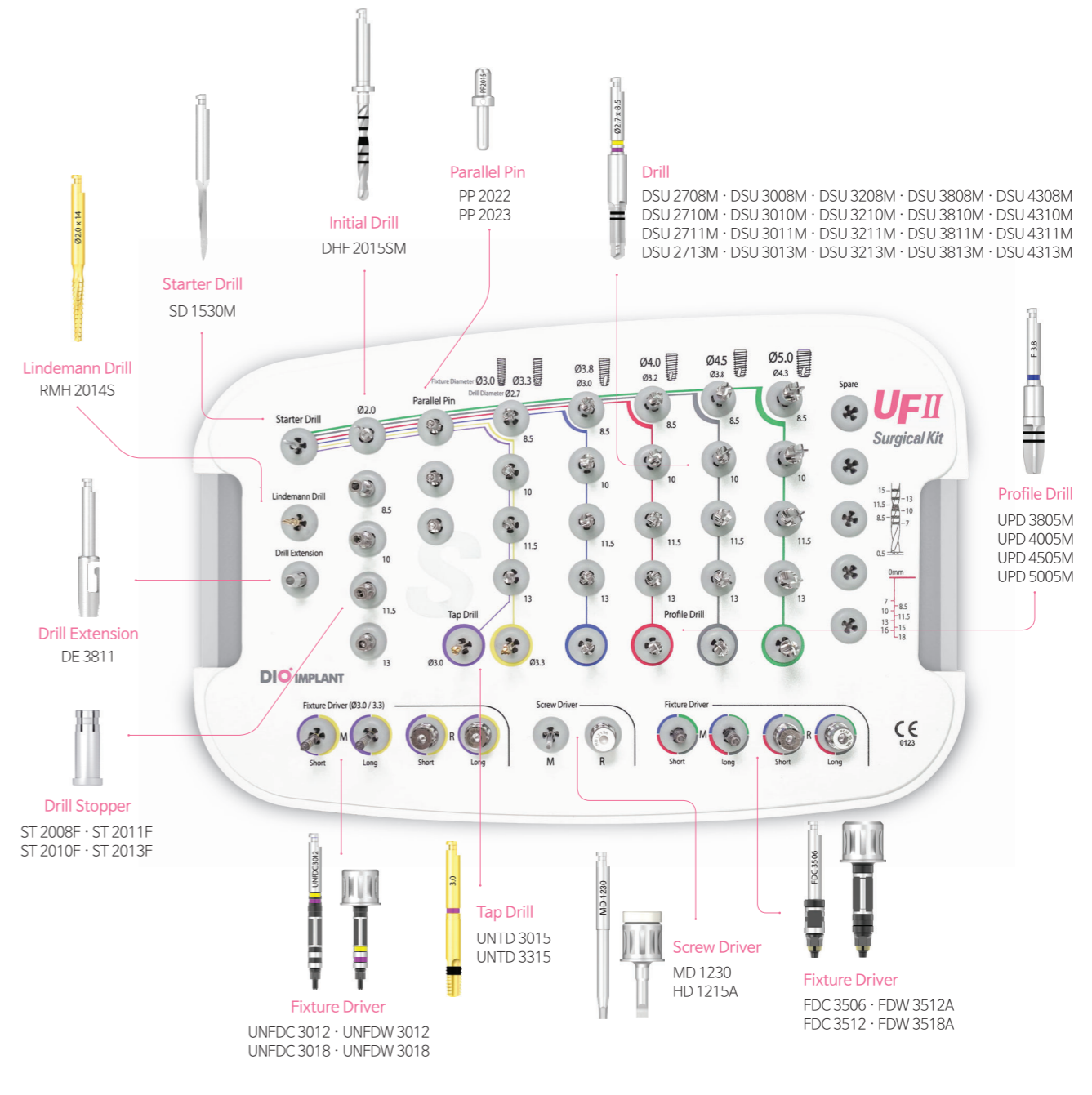

Ver B

Surgical Tool

Starter Drill

K Unit mm | Scale 1:1.15

Code	SD 1530M
------	----------

Initial Drill

K D Ø2.0 · Only use UFI Master Kit Unit mm | Scale 1:1

Code	DSU 2008M	DSU 2010M	DSU 2011M	DSU 2013M
------	-----------	-----------	-----------	-----------

K D Ø2.0 · Only use UFI Surgical Kit Unit mm | Scale 1:1.2

Code	DHF 2015SM
------	------------

Drill stopper

K D Ø2.0 · Only use UFI Surgical Kit Unit mm | Scale 1:1

Code	ST 2008F	ST 2010F	ST 2011F	ST 2013F
------	----------	----------	----------	----------

Parallel Pin

K Unit mm | Scale 1:1

Code	PP 1223	PP 1523	PP 2015	PP 2022	PP 2023
------	---------	---------	---------	---------	---------

Path Pin

K Unit mm | Scale 1:1.2

Code	DPP 3512
------	----------

Lindemann Drill

K D Ø2.0 Unit mm | Scale 1:1.2

Code	RMH 2014S
------	-----------

Positioning Guide

K D Ø2.0 Unit mm | Scale 1:1.2

Code	PG 0060
------	---------

Angled Path Pin

K Unit mm | Scale 1:1.15

Code	DAP 4515A	DAP 4515B
------	-----------	-----------

Surgical Tool

Drill



K D Ø2.7

Unit mm | Scale 1:1

Code DSU 2708M DSU 2710M DSU 2711M DSU 2713M **DSU 2715M** **DSU 2718M**



Length | 8.5 10 11.5 13 15 18

● Sold separately

K D Ø3.0

Unit mm | Scale 1:1

Code DSU 3008M DSU 3010M DSU 3011M DSU 3013M **DSU 3015M** **DSU 3018M**



Length | 8.5 10 11.5 13 15 18

K D Ø3.2

Unit mm | Scale 1:1

Code DSU3208M DSU 3210M DSU 3211M DSU 3213M **DSU 3215M** **DSU 3218M**



Length | 8.5 10 11.5 13 15 18

K D Ø3.8

Unit mm | Scale 1:1

Code DSU 3808M DSU 3810M DSU 3811M DSU 3813M **DSU 3815M** **DSU 3818M**



Length | 8.5 10 11.5 13 15 18

K D Ø4.3

Unit mm | Scale 1:1

Code DSU4308M DSU 4310M DSU 4311M DSU 4313M **DSU 4315M** **DSU 4318M**



Length | 8.5 10 11.5 13 15 18

Surgical Tool

Profile Drill

K Unit mm | Scale 1:1

Fixture Size	Ø3.8	Ø4.0	Ø4.5	Ø5.0
Code	UPD 3805M	UPD 4005M	UPD 4505M	UPD 5005M

Color | ● ● ● ●

Tap Drill

K Unit mm | Scale 1:1

Fixture Size	Ø3.0	Ø3.3	Ø3.8	Ø4.0	Ø4.5	Ø5.0	Ø5.5
Code	UNTD 3015	UNTD 3315	UT(II) 3815	UT(II) 4015	UT(II) 4515	UT(II) 5015	UT(II) 5515

Color | ● ● ● ● ● ● ●

Drill Extension

K Unit mm | Scale 1:1.2

Code	DE 3811
------	---------

Fixture Driver Narrow

K Machine Unit mm | Scale 1:1

Code	UNFDC 3006	UNFDC 3012	UNFDC 3018
------	------------	------------	------------

● Sold separately

K Ratchet Unit mm | Scale 1:1

Code	UNFDW 3006	UNFDW 3012	UNFDW 3018
------	------------	------------	------------

Fixture Driver Regular / Wide

K Machine Unit mm | Scale 1:1

Code	FDC 3506	FDC 3512	FDC 3518
------	----------	----------	----------

● Sold separately

K Ratchet Unit mm | Scale 1:1

Code	FDW 3506A	FDW 3512A	FDW 3518A
------	-----------	-----------	-----------

Surgical Tool

Screw Driver Machine

● Sold separately

K Slot 0.5	Unit mm Scale 1:1	
Code	MD 0522	MD 0530



K Hex 0.9	Unit mm Scale 1:1	
Code	MD 0922	MD 0930

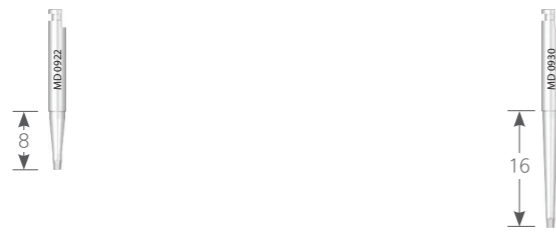

K Hex 1.2	Unit mm Scale 1:1				
Code	MD 1219	MD 1222	MD 1230	MD 1234	MD 1239

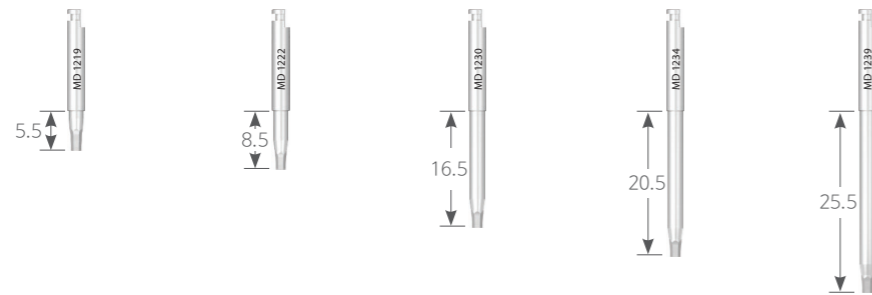

K Torx 1.7	Unit mm Scale 1:1		
Code	MD 1719	MD 1722	MD 1730



Screw Driver Ratchet

● Sold separately

K Slot 0.5	Unit mm Scale 1:1	
Code	HD 0510A	HD 0515A



K Hex 0.9	Unit mm Scale 1:1		
Code	HD 0910A	HD 0915A	HD 0920A

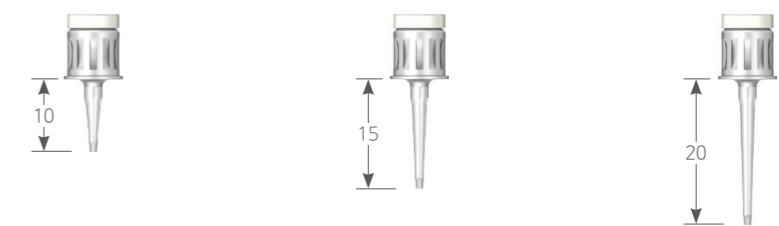

K Hex 1.2	Unit mm Scale 1:1					
Code	HD 1205A	HD 1210A	HD 1215A	HD 1220A	HD 1225A	HD 1230A

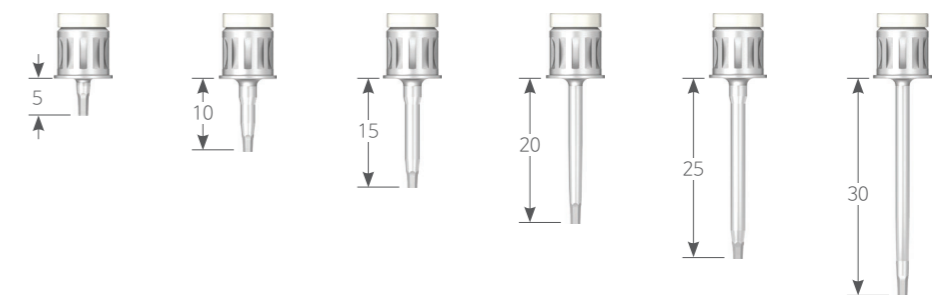

K Torx 1.7	Unit mm Scale 1:1				
Code	HD 1705A	HD 1710A	HD 1715A	HD 1720A	HD 1725A

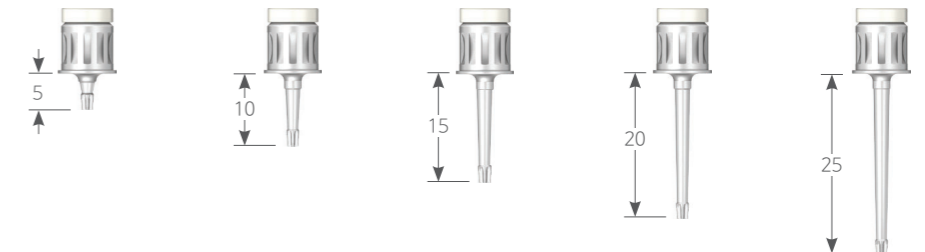

Surgical Tool

Fixture Mount Driver

· Only use UF II Master Kit

K Hex 2.5 Unit mm | Scale 1:1

Type	Machine		Ratchet	
Code	MHDC 2520	MHDC 2525	MHDR 2513A	MHDR 2518A

Solid Abutment Driver

· Only use UF II Master Kit

K Unit mm | Scale 1:1.2

Length	6	12
--------	---	----

Diameter Ø4.5	HDS 4506A	HDS 4512A
Ø5.5	HDS 5506A	HDS 5512A
Ø6.5	HDS 6506A	HDS 6512A

Ball Abutment Driver

· Only use UF II Master Kit

● Sold separately

K Unit mm | Scale 1:1

Code	HD 2406A	HD 2412A
------	----------	----------

Abutment Removing Driver

· Only use UF II Master Kit

K Unit mm | Scale 1:1

Code	HARD 20315A	HARD 20320A
------	-------------	-------------

Surgical Tool

Depth Gauge



K D Ø2.0

Unit mm | Scale 1:1

Code

DPG 2050

Open Wrench

- Used to remove Mount if the bone is soft.
- 30° Neck angle for convenience in intraoral insertion.



K

Unit mm | Scale 1:1

Code

OW 004

Torque Wrench



K

Unit mm | Scale 1:1

Code

DTW 0060

Surgical Protocol

Crestal Placement

Starter Drill 1,200rpm Initial Drill 1,000rpm Drill 800rpm Profile Drill 300rpm Tap Drill 50rpm UF(II) Fixture 20rpm

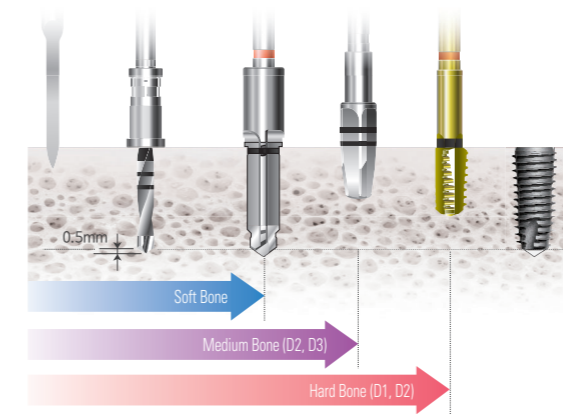

1mm Subcrestal Placement

Starter Drill 1,200rpm Initial Drill 1,000rpm Drill 800rpm Profile Drill 300rpm Tap Drill 50rpm UF(II) Fixture 20rpm

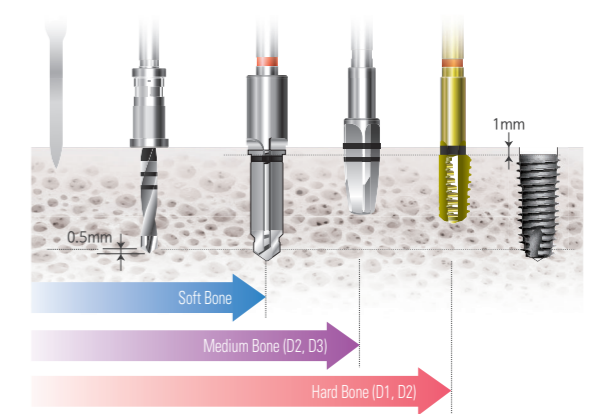

Drill
Using 8.5mm Drill with laser marking to place 7mm implant

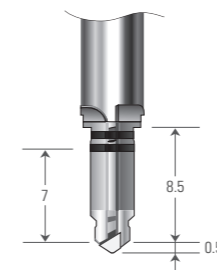

Profile Drill
Drilling depth can effect initial stability.

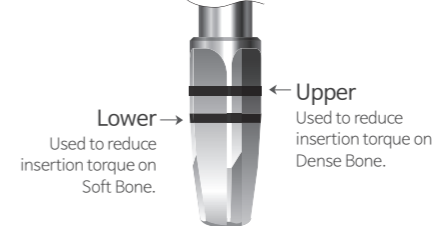

Tap Drill

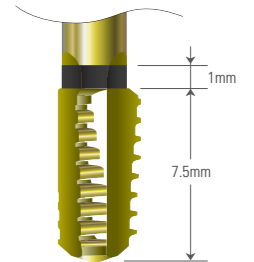

UF II Narrow Kit Kit Code I UF(M) 08

- Kit composed of drill with outstanding cutting force and durability, etc.
- UF II Narrow $\varnothing 3.0$ $\varnothing 3.3$ Fixture

Unit mm | Drill Scale 1 : 0.9

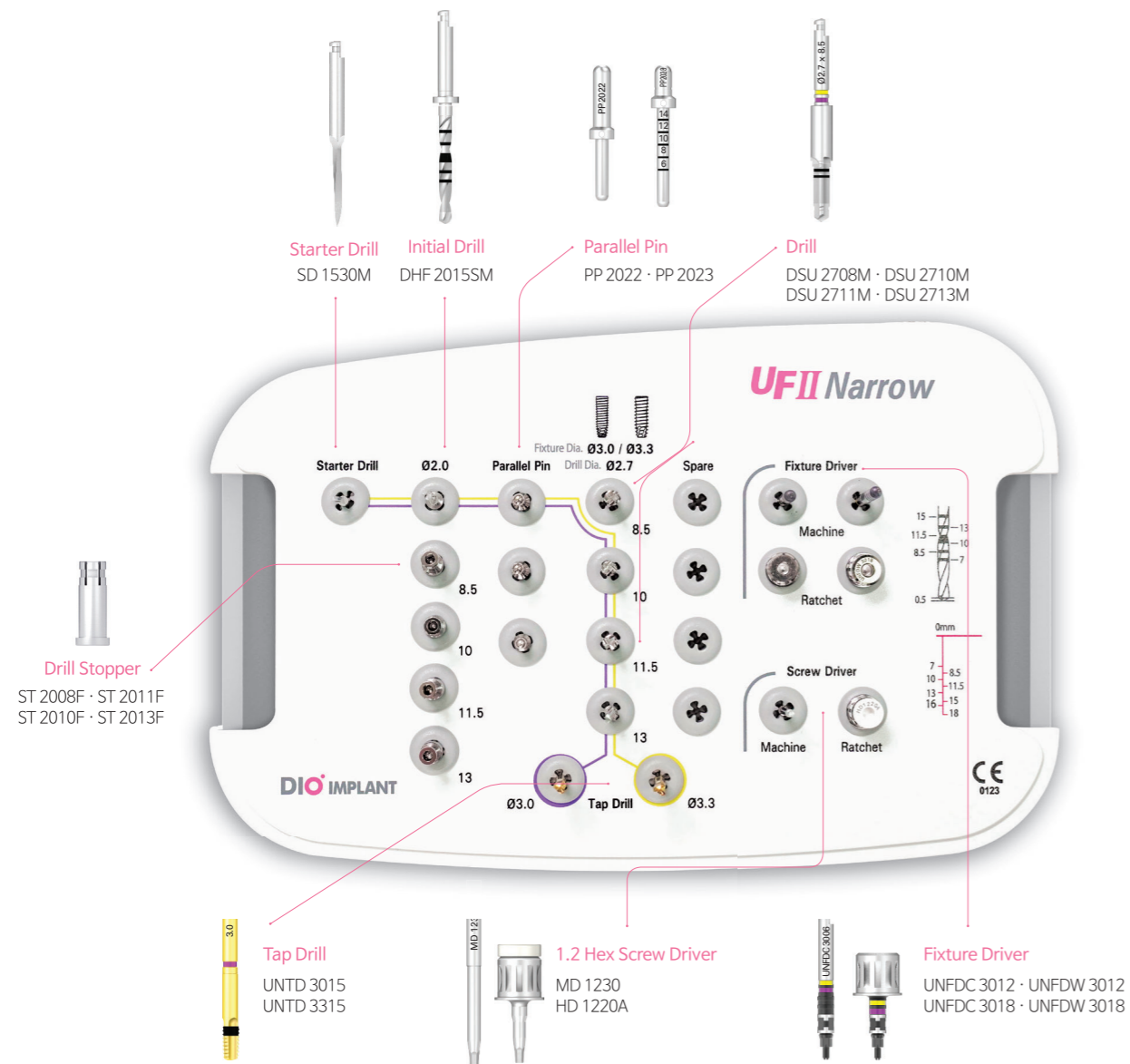

Surgical Tool

Starter Drill

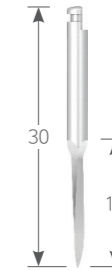

Unit mm | Scale 1 : 1.2

K	Code	SD 1530M
----------	------	----------

Initial Drill

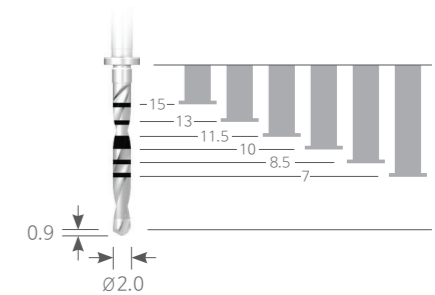

Unit mm | Scale 1 : 1.2

K	D $\varnothing 2.0$	Code	DHF 2015SM
----------	---------------------	------	------------

Drill stopper

K	D $\varnothing 2.0$	Unit mm Scale 1 : 1			
Code		ST 2008F	ST 2010F	ST 2011F	ST 2013F



Parallel Pin

K	D $\varnothing 2.0$	Unit mm Scale 1 : 1	
Code		PP 2022	PP 2023

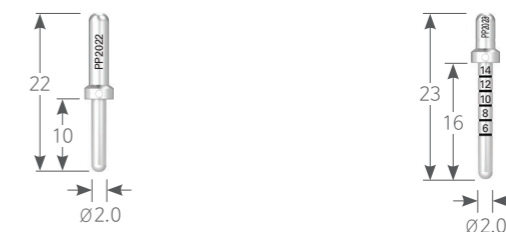

Surgical Tool

Drill

K D Ø2.7 Unit mm | Scale 1:1

Code	DSU 2708M	DSU 2710M	DSU 2711M	DSU 2713M
------	-----------	-----------	-----------	-----------

Tap Drill

K Unit mm | Scale 1:1

Fixture Size	Ø3.0	Ø3.3
Code	UNTD 3015	UNTD 3315

Fixture Driver

- Maximum Tightening Torque : 50Ncm
- Drill lifespan : 20 oseotomies

K Unit mm | Scale 1:1

Type	Machine			Ratchet		
Code	UNFDC 3006	UNFDC 3012	UNFDC 3018	UNFDW 3006	UNFDC 3012	UNFDC 3018

Screw Driver

K Hex 1.2 Unit mm | Scale 1:1

Type	Machine	Ratchet
Code	MD 1230	HD 1220A

Solid Abutment Driver

• Only use UFI Narrow Kit

K D Ø4.0 Unit mm | Scale 1:1

Length	6	12
Code	UNHDS 4006A	UNHDS 4012A

Surgical Protocol

Starter Drill 1,200rpm
Initial Drill 1,000rpm
Drill 800rpm
Tap Drill 50rpm
UF(II) Narrow Fixture 20rpm

Soft Bone
Medium Bone (D2, D3)
Hard Bone (D1, D2)

Tap Drill
1.5mm
4mm

• Tightening torque : 20~40Ncm
Maximum tightening torque : 50Ncm

UFII Wide Kit Kit Code | UF 09

- Kit composed of drill with outstanding cutting force and durability, etc.
- UF II Wide Ø5.9 Ø6.4 Ø6.9 Fixture

Unit mm | Drill Scale 1 : 0.9

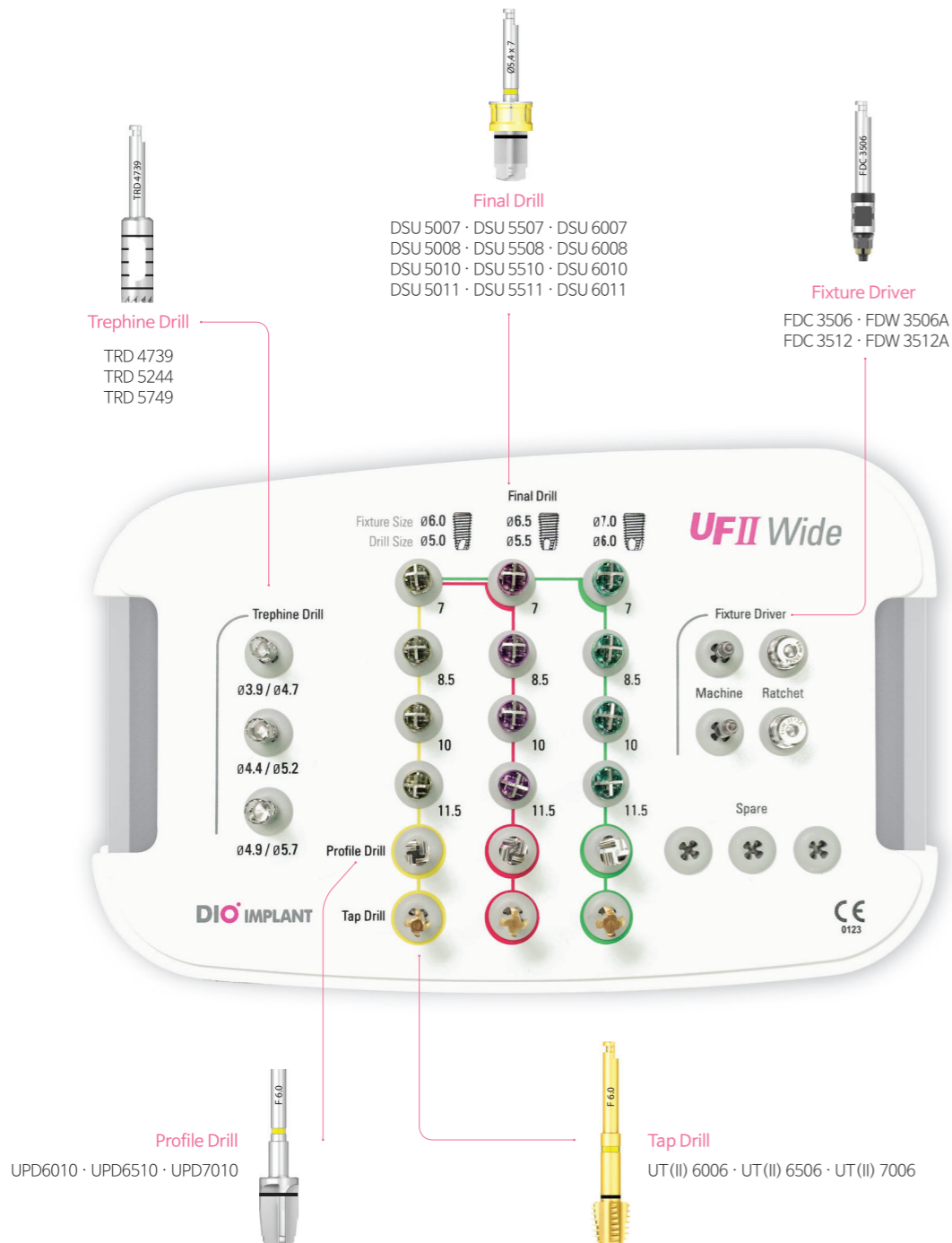

Surgical Tool

Trepine Drill



Scale 1 : 1.15

Unit mm | Scale 1 : 1

Code	TRD 4739	TRD 5244	TRD 5749
Diameter 1	Ø3.9	Ø4.4	Ø4.9
Diameter 2	Ø4.7	Ø5.2	Ø5.7

Profile Drill



Scale 1 : 1.15

Fixture Size	Ø6.0	Ø6.5	Ø7.0
Code	UPD 6010	UPD 6510	UPD 7010
Color	Yellow	Red	Green

Surgical Tool

Final Drill

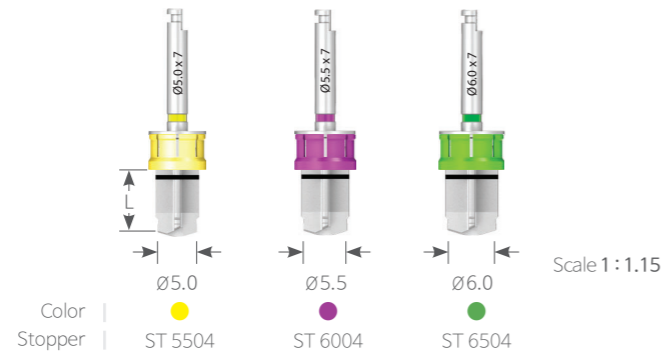

K D Ø5.0

● Sold separately
Unit mm | Scale 1 : 1

Code	DSU 5007	DSU 5008	DSU 5010	DSU 5011	DSU 5013	DSU 5015
------	----------	----------	----------	----------	-----------------	-----------------



Length	7	8.5	10	11.5	13	15
--------	---	-----	----	------	----	----

K D Ø5.5

Code	DSU 5507	DSU 5508	DSU 5510	DSU 5511	DSU 5513	DSU 5515
------	----------	----------	----------	----------	-----------------	-----------------



Length	7	8.5	10	11.5	13	15
--------	---	-----	----	------	----	----

K D Ø6.0

Code	DSU 6007	DSU 6008	DSU 6010	DSU 6011	DSU 6013	DSU 6015
------	----------	----------	----------	----------	-----------------	-----------------



Length	7	8.5	10	11.5	13	15
--------	---	-----	----	------	----	----

Tap Drill

K

Unit mm | Scale 1 : 1

Fixture Size	Ø6.0	Ø6.5	Ø7.0
Code	UT (II) 6006	UT (II) 6506	UT (II) 7006



Color	Yellow	Red	Green
-------	--------	-----	-------

Fixture Driver

K D Ø2.7

● Sold separately
Unit mm | Scale 1 : 1

Type	Machine			Ratchet		
Code	FDC 3506	FDC 3512	FDC 3518	FDW 3506A	FDW 3512A	FDW 3518A

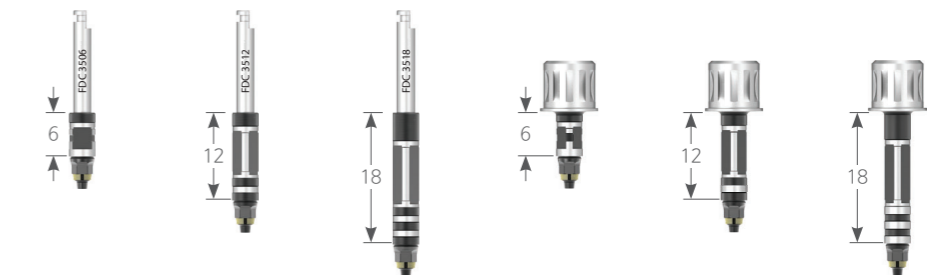

Surgical Protocol

Fixture Length 7mm

Extraction Socket & Replace failed Implant

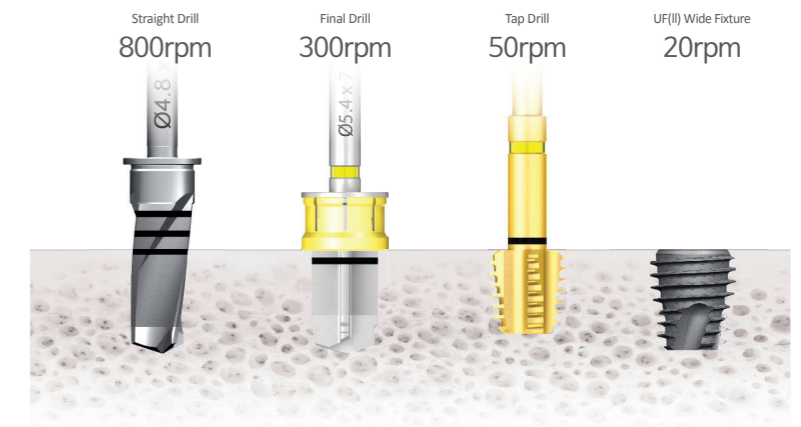

DIO
www.dionavi.com

DIGITAL MATERIALS

DIGITAL MATERIALS

DIO PRODUCT CATALOG

Anatomic Abutment

Scan Adapter Function

Marking

L25 · L Lower Incisor	2 Cuff Height	5 Post Height
U25 · U Upper Incisor	2 Cuff Height	5 Post Height
C25 · C Canine	2 Cuff Height	5 Post Height
P25 · P Pre-Molar	2 Cuff Height	5 Post Height
M25 · M Molar	2 Cuff Height	5 Post Height

Attention

0.5 unit marking exempted in accordance with marketing
ex) Cuff 2.5 = 2 / Post 5.5 = 5

Protect Cap
Lock-Groove

Shoulder Margin



UF II Connection



UF II
Connection



UF II Narrow
Connection



Non-Hex



Lower Incisor



Upper Incisor



Canine



Pre-Molar



Molar

	Lower Incisor	Upper Incisor	Canine	Pre-Molar	Molar
Cross Section					
Cervical Margin Cross Section					
Facial Side					
Connection	UF(II) Narrow	UF(II) Narrow / UF(II)	UF(II)	UF(II)	UF(II)
Cervical Margin Dimension (Mesiodistal x faciolingual)	5 X 5.2	6.1 X 5.7	5.3 X 6.3	5.8 X 6.8	7.3 X 7.8
Ratio (%)	70%	70% / 85%	85%	85%	85%

Lower Incisor

UFI Narrow Anatomic Abutment Hex Non-Hex

- Packing Unit : Abutment + Abutment Screw
If a protect cap is included in the abutment + abutment screw, model name + [C]
- Abutment Screw : UNSAS 1407H (Only compatible with the screw included.)

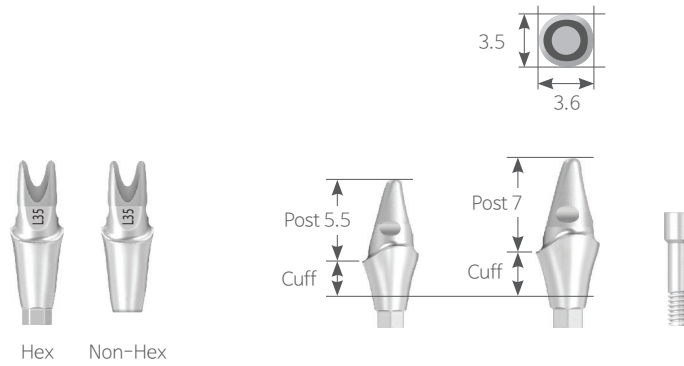

N Post 5.5

Unit mm | Scale 1 : 1.25

Cuff	2.5	3.5	4.5	5.5	Protect Cap
Hex	DLN 2555H	DLN 3555H	DLN 4555H	DLN 5555H	DCLN 55
Non-Hex	DLN 2555N	DLN 3555N	DLN 4555N	DLN 5555N	DCLN 55
Marking	L 25	L 35	L 45	L 55	-

N Post 7.0

Cuff	2.5	3.5	4.5	5.5	Protect Cap
Hex	DLN 2570H	DLN 3570H	DLN 4570H	DLN 5570H	DCLN 70
Non-Hex	DLN 2570N	DLN 3570N	DLN 4570N	DLN 5570N	DCLN 70
Marking	L 27	L 37	L 47	L 57	-

Upper Incisor

UFI Narrow Anatomic Abutment Hex Non-Hex

· Packing Unit : Abutment + Abutment Screw

If a protect cap is included in the abutment + abutment screw, model name + [C]



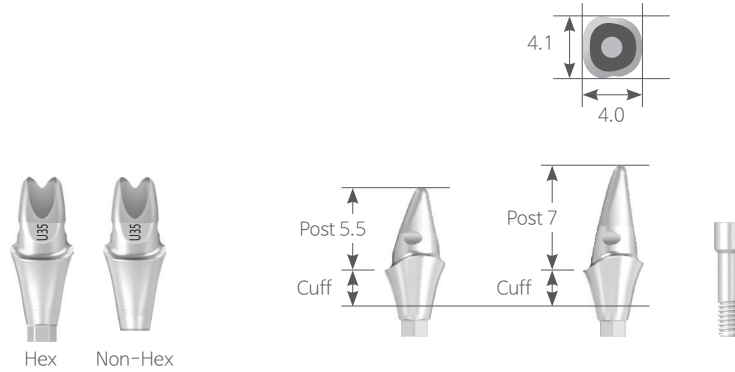

· Abutment Screw : UNSAS 1407H (Only compatible with the screw included.)



N Post 5.5





Unit mm | Scale 1 : 1.25

Cuff	2.5	3.5	4.5	5.5	Protect Cap
------	-----	-----	-----	-----	-------------

					
Hex	DUN 2555H	DUN 3555H	DUN 4555H	DUN 5555H	DCUN 55
Non-Hex	DUN 2555N	DUN 3555N	DUN 4555N	DUN 5555N	DCUN 55
Marking	U 25	U 35	U 45	U 55	-

N Post 7.0

Cuff	2.5	3.5	4.5	5.5	Protect Cap
------	-----	-----	-----	-----	-------------

					
Hex	DUN 2570H	DUN 3570H	DUN 4570H	DUN 5570H	DCUN 70
Non-Hex	DUN 2570N	DUN 3570N	DUN 4570N	DUN 5570N	DCUN 70
Marking	U 27	U 37	U 47	U 57	-

Upper Incisor

UFI^{II} Anatomic Abutment Hex Non-Hex



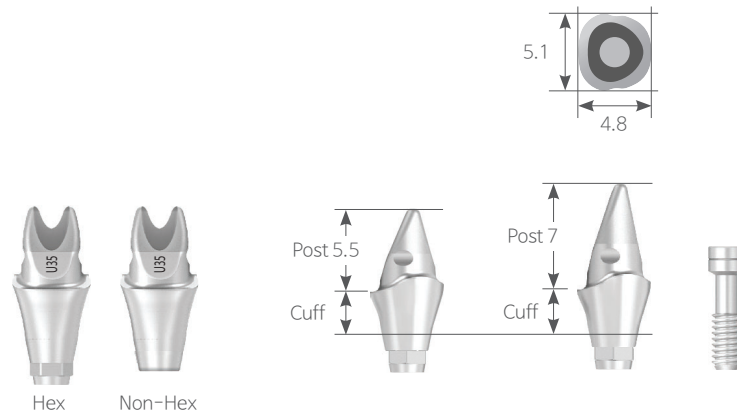

· Abutment Screw : DASC 2008H (Only compatible with the screw included.)



DIGITAL MATERIALS

R Post 5.5

Unit mm | Scale 1 : 1.25

Cuff	2.5	3.5	4.5	5.5	Protect Cap
					
Hex	DUR 2555H	DUR 3555H	DUR 4555H	DUR 5555H	DCUR 55
Non-Hex	DUR 2555N	DUR 3555N	DUR 4555N	DUR 5555N	DCUR 55
Marking	U 25	U 35	U 45	U 55	-

R Post 7.0

Cuff	2.5	3.5	4.5	5.5	Protect Cap
					
Hex	DUR 2570H	DUR 3570H	DUR 4570H	DUR 5570H	DCUR 70
Non-Hex	DUR 2570N	DUR 3570N	DUR 4570N	DUR 5570N	DCUR 70
Marking	U 27	U 37	U 47	U 57	-

Canine

UFII Anatomic Abutment Hex Non-Hex

· Abutment Screw : DASC 2008H (Only compatible with the screw included.)

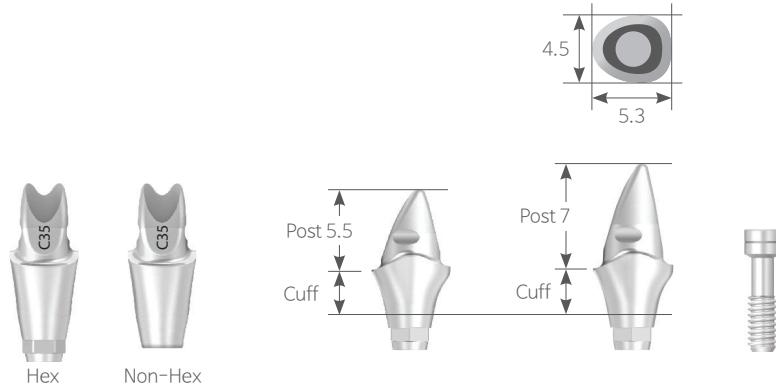

R Post 5.5



Unit mm | Scale 1 : 1.25

Cuff	2.5	3.5	Protect Cap
------	-----	-----	-------------

				
Hex		DCR 2555H	DCR 3555H	DCCR 55
Non-Hex		DCR 2555N	DCR 3555N	DCCR 55
Marking		C 25	C 35	-

R Post 7.0

Cuff	2.5	3.5	Protect Cap
------	-----	-----	-------------

				
Hex		DCR 2570H	DCR 3570H	DCCR 70
Non-Hex		DCR 2570N	DCR 3570N	DCCR 70
Marking		C 27	C 37	-

Pre-Molar

UFII Anatomic Abutment Hex Non-Hex

· Abutment Screw : DASC 2008H (Only compatible with the screw included.)

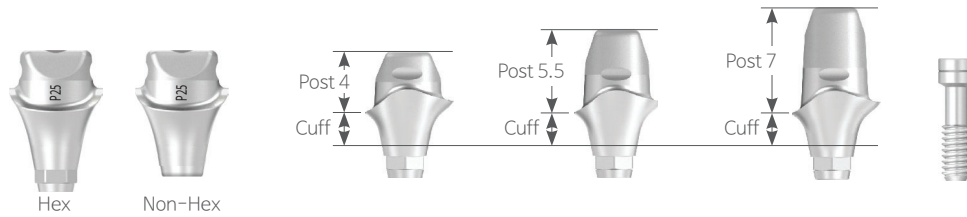
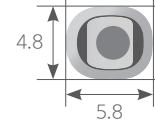

DIGITAL MATERIALS

R Post 4.0

Unit mm | Scale 1 : 1.25

Cuff	1.5	2.5	3.5	4.5	Protect Cap
Hex	DPR 1540H	DPR 2540H	DPR 3540H	DPR 4540H	DCPR 40
Non-Hex	DPR 1540N	DPR 2540N	DPR 3540N	DPR 4540N	DCPR 40
Marking	P 14	P 24	P 34	P 44	-

R Post 5.5

Cuff	1.5	2.5	3.5	4.5	Protect Cap
Hex	DPR 1555H	DPR 2555H	DPR 3555H	DPR 4555H	DCPR 55
Non-Hex	DPR 1555N	DPR 2555N	DPR 3555N	DPR 4555N	DCPR 55
Marking	P 15	P 25	P 35	P 45	-

R Post 7.0

Cuff	1.5	2.5	3.5	4.5	Protect Cap
Hex	DPR 1570H	DPR 2570H	DPR 3570H	DPR 4570H	DCPR 70
Non-Hex	DPR 1570N	DPR 2570N	DPR 3570N	DPR 4570N	DCPR 70
Marking	P 17	P 27	P 37	P 47	-

Molar

UFII Anatomic Abutment

Hex Non-Hex

· Abutment Screw : DASC 2008H (Only compatible with the screw included.)

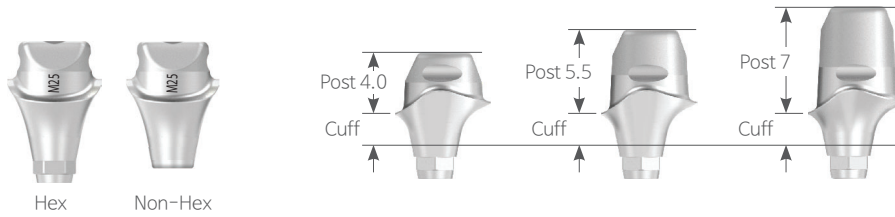
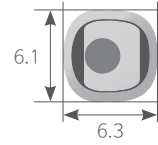

R Post 4.0

Unit mm | Scale 1 : 1.25

Cuff	1.5	2.5	3.5	4.5	Protect Cap
Hex	DMR 1540H	DMR 2540H	DMR 3540H	DMR 4540H	DCMR 40
Non-Hex	DMR 1540N	DMR 2540N	DMR 3540N	DMR 4540N	DCMR 40
Marking	M 14	M 24	M 34	M 44	-

R Post 5.5

Cuff	1.5	2.5	3.5	4.5	Protect Cap
Hex	DMR 1555H	DMR 2555H	DMR 3555H	DMR 4555H	DCMR 55
Non-Hex	DMR 1555N	DMR 2555N	DMR 3555N	DMR 4555N	DCMR 55
Marking	M 15	M 25	M 35	M 45	-

R Post 7.0

Cuff	1.5	2.5	3.5	4.5	Protect Cap
Hex	DMR 1570H	DMR 2570H	DMR 3570H	DMR 4570H	DCMR 70
Non-Hex	DMR 1570N	DMR 2570N	DMR 3570N	DMR 4570N	DCMR 70
Marking	M 17	M 27	M 37	M 47	-

Carrier

- Easier delivery to the intra oral area
(Only require the driver)
- Carrier prevents screw from dropping into the patients throat to mouth
- Easier handling and a more precise connection

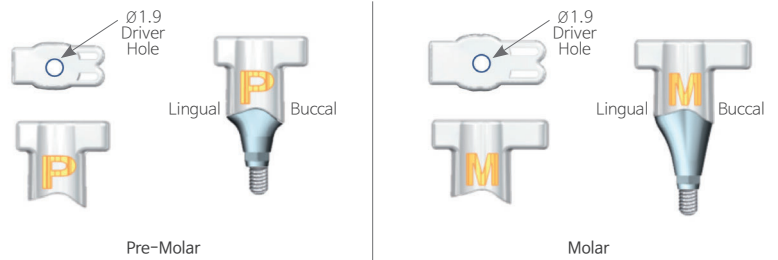

Type	Pre-Molar	Molar
Code	DJPR 00	DJMR 00

Protect Cap

1. Prevention of gingiva creeping
 - Covering of gum in the margin and gingiva retraction
 - Can accurately take impression with widened gum
2. Protection of the patient's tongue
 - Since the protect cap can fall off while biting food with antagonist teeth (sticky food, etc.), be careful not to swallow the cap if fallen.



How to check the path

Flapless Surgery

- Surgical Guide Fix (Can check height of the gum)

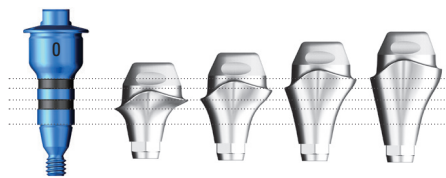

- Setting of hex direction to buccal side when using anatomic abutment, checking of hex direction using guide sleeve projection
- Can check hex direction using a Guide Sleeve

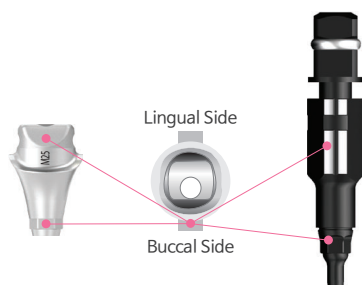

Flap Surgery

- Setting of hex direction to buccal side when using anatomic abutment
- Can check hex direction using a fixture driver

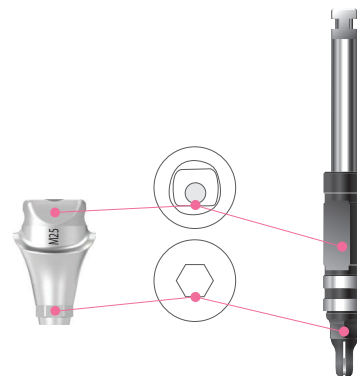

Workflow

DIONavi. + Anatomic Abutment (Full Digital)

Immediate Restoration

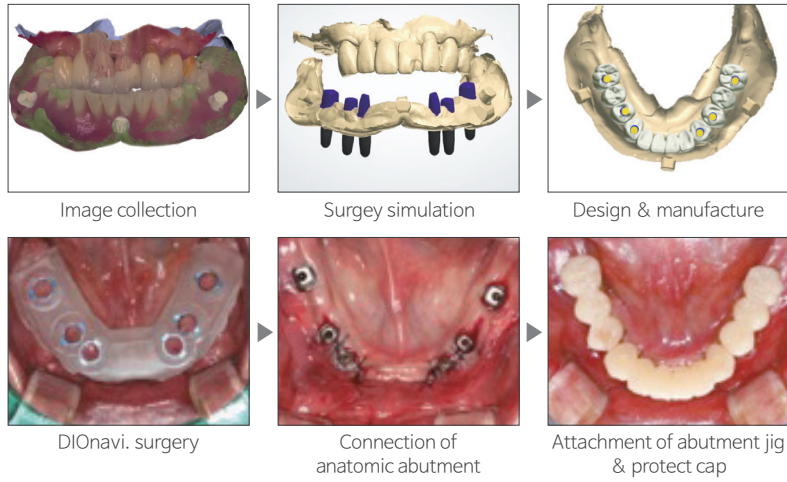

Method of intra oral scan impression

If oral scan is available

Method of library matching
(3Shape Dental System)



Method of conventional impression

Scanning after manufacture of model

Method of library matching
(3Shape Dental System)



Scan Adapter

- Manufacture of customized abutment by connecting to the fixture in the mouth or lab analog of the plaster model and scanning with an oral scanner or desk scanner
- [H] : Hex / [T] :Torx

UFII Narrow

- Packing Unit : Scan Adapter + Screw
- Tightening Torque : 5~8Ncm

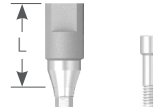

N		Unit mm Scale 1 : 1.25		
Length	9	15	Screw	
	SCAN 41	SCAN 41-15	UNSAS 1407H	

UFII Regular / Wide

- Packing Unit : Scan Adapter + Screw
- Tightening Torque : 5~8Ncm

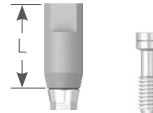

R W				
Length	9	15	Screw	
Hex		SCAN 01 [H]	SCAN 01-15 [H]	SSC 2008H
Torx		SCAN 01 [T]	SCAN 01-15 [T]	SSC 2008H

Scan Retractor

- Precise recognition of maxillar open repository and archive
- Controlling the cheek and tongue mobility at mandibular open repository and archive
- Providing the exact reference point of the marginal scanning area
- Packing Unit : Maxillar - Set (5 Piece) Mandibular - Set (5 Piece)



Type	Maxillar	Mandibular
	SCANR 01S	SCANR 02S

Wax Denture

- ▶ Made of thermoplastic material that allows easy operation to acquire occlusion with patient's gingiva
- For edentulous patients
- Easily customized
- Enable oral scan · Packing Unit : Maxillar-1 Piece / Mandibular-1 Piece



Type	Maxillar	Mandibular
Small	WDU 01	WDL 01
Medium	WDU 02	WDL 02
Large	WDU 03	WDL 03

Marker

- Use when they have no teeth for reference
- Use for CT imaging for digital implant surgery
- Packing Unit : 1Set (30ea)



Type	SGM 5040

Pre-Milled Bar

UFII Narrow

- Packing Unit : Pre-Milled Bar + Screw (UNSAS 1407H) (2ea)
- Tightening Torque : 20Ncm



N Unit mm | Scale 1:1

Type	Hex		Non-Hex	
Diameter	Ø10	Ø12	Ø10	Ø12
	CBUN 01	CBUN 02	CBUN 01N	CBUN 02N

UFII Regular / Wide

- Packing Unit : Pre-Milled Bar + Screw (SSC 2008H) (2ea)
- Tightening Torque : 30~35Ncm



R W Unit mm | Scale 1:1

Type	Hex		Non-Hex	
Diameter	Ø10	Ø12	Ø10	Ø12
	CBSS 01	CBSS 02	CBSS 01N	CBSS 02N

Hybrid Link

- Up to implant platform connection part is made of titanium, making it easy to produce prosthesis for anterior teeth by cementation the post made of zirconia

UFII Narrow

- Packing Unit : Hybrid Link + Screw (UNSA1407H)
- Tightening Torque : 20Ncm

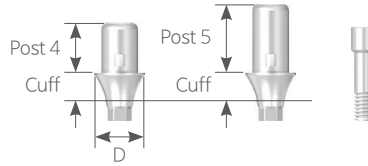

N D Ø4.0

Unit mm | Scale 1 : 1.65

Type			Hex
Diameter Ø4.0	Post 4	Cuff 1	UNHL 40401H
		Cuff 2	UNHL 40402H
		Cuff 3	UNHL 40403H
Post 5	Cuff 1	UNHL 40551H	
	Cuff 2	UNHL 40552H	
	Cuff 3	UNHL 40553H	

UFII Regular / Wide

- Packing Unit : Hybrid Link + Screw (SSC 2008H)
- Tightening Torque : 30~35Ncm

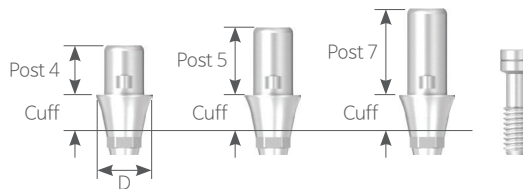

R W

Unit mm | Scale 1 : 1.65

Type			Hex	Non-Hex
Diameter Ø4.5	Post 4	Cuff 1	UFHL 45401H	UFHL 45401N
		Cuff 2	UFHL 45402H	UFHL 45402N
		Cuff 3	UFHL 45403H	UFHL 45403N
	Post 5	Cuff 1	UFHL 45501H	UFHL 45501N
		Cuff 2	UFHL 45502H	UFHL 45502N
		Cuff 3	UFHL 45503H	UFHL 45503N
	Post 7	Cuff 1	UFHL 45701H	UFHL 45701N
		Cuff 2	UFHL 45702H	UFHL 45702N
		Cuff 3	UFHL 45703H	UFHL 45703N
Diameter Ø5.5	Post 4	Cuff 1	UFHL 55401H	UFHL 55401N
		Cuff 2	UFHL 55402H	UFHL 55402N
		Cuff 3	UFHL 55403H	UFHL 55403N
	Post 5	Cuff 1	UFHL 55501H	UFHL 55501N
		Cuff 2	UFHL 55502H	UFHL 55502N
		Cuff 3	UFHL 55503H	UFHL 55503N
	Post 7	Cuff 1	UFHL 55701H	UFHL 55701N
		Cuff 2	UFHL 55702H	UFHL 55702N
		Cuff 3	UFHL 55703H	UFHL 55703N

DIO
www.dionavi.com

DIONAVI.

DIONAVI.

DIO PRODUCT CATALOG

DIONavi. Master Kit Kit Code | UF(M) 05

- Kit composed of drill with outstanding cutting force and durability, etc.
- UFII Narrow Ø3.0 Ø3.3 UF(II) Regular Ø3.8 Ø4.0 Ø4.5 Ø5.0 Fixture
- Guide Sleeve : GS 53

Unit mm | Drill Scale 1 : 0.9

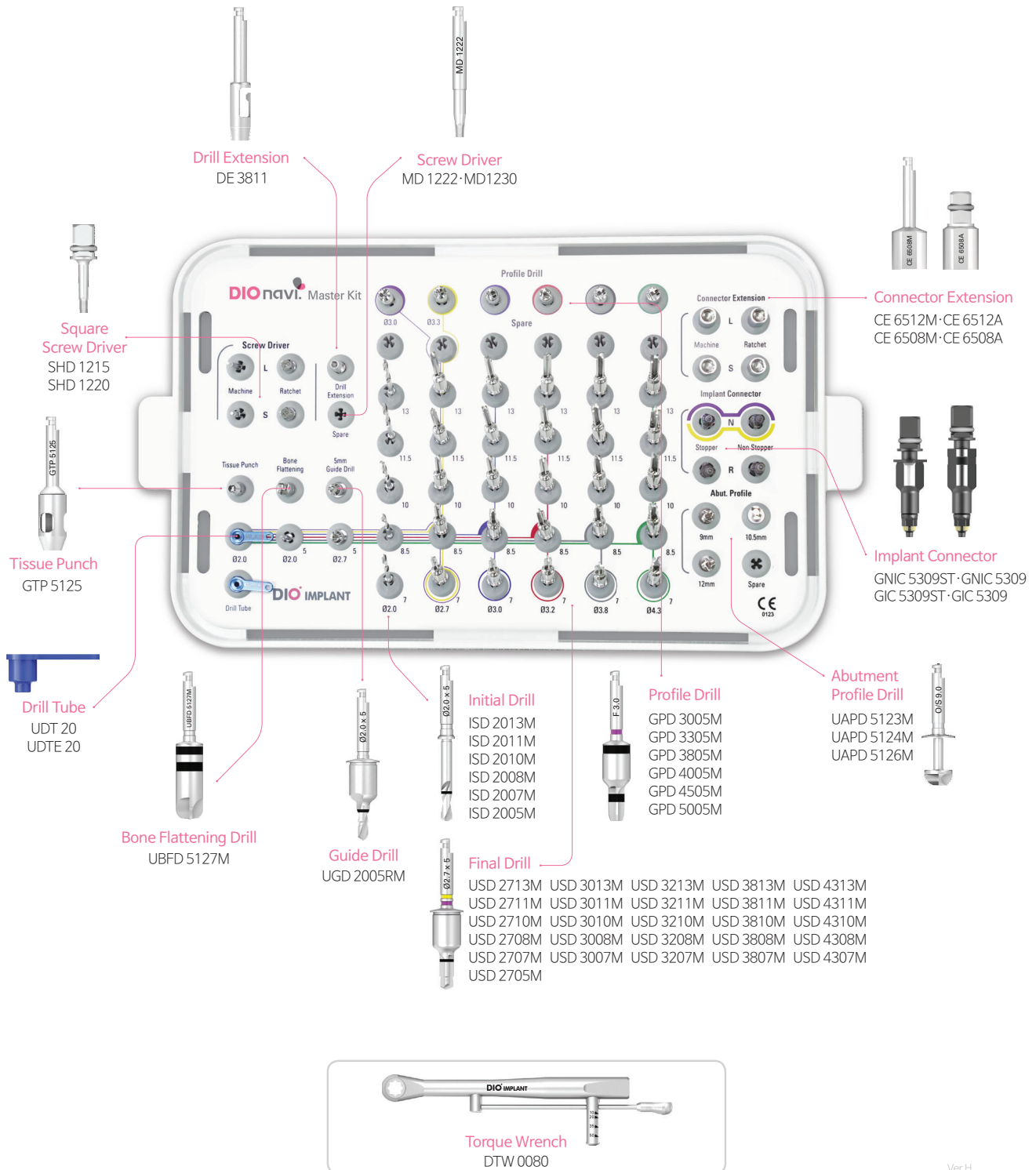

Surgical Tool

Tissue Punch

- Gingiva can be removed stably using a fixed blade inside the punch.
(Flapless Surgery)



K D $\varnothing 3.0$

Unit mm | Scale 1:1

Code

GTP 5125

Bone Flattening Drill

- Remaining gingiva is removed for easier drilling,
and irregular alveolar crest is flattened.

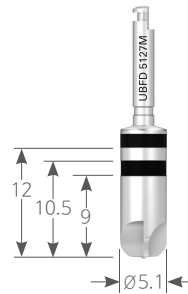

K D $\varnothing 5.1$

Unit mm | Scale 1:1

Code

UBFD 5127M

Guide Drill

- A hole on the bone is initially formed
on the bone for easier insertion of the initial drill.



K D $\varnothing 2.0$ Length 5

Unit mm | Scale 1:1

Code

UGD 2005RM

Drill Extension

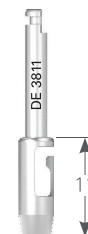

K Length 11

Unit mm | Scale 1:1

Code

DE 3811

Surgical Tool

Drill Tube

· To fix the guide drill and the initial drill without shakage.



Unit mm
Scale 1 : 1.2

● Sold separately

K	Code	UDT 20	UDTE 20	UDTL 20
----------	------	--------	---------	---------

Unit mm | Scale 1 : 1



Initial Drill

· A placement hole (osteotomy site) is formed on the cortical bone.

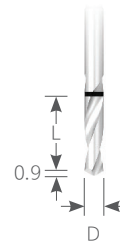

● Sold separately

K	Code	ISD 2005M	ISD 2007M	ISD 2008M	ISD 2010M	ISD 2011M	ISD 2013M	ISD 2015M
----------	------	-----------	-----------	-----------	-----------	-----------	-----------	-----------

Unit mm | Scale 1 : 1



Profile Drill

- The cortical bone is further drilled in D1 and D2 bones, and excessive placement torque is prevented.

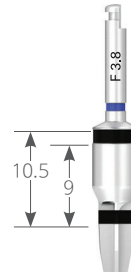

K

Unit mm | Scale 1 : 1

Fixture Size	Ø3.0	Ø3.3	Ø3.8	Ø4.0	Ø4.5	Ø5.0
Code	GPD 3005M	GPD 3305M	GPD 3805M	GPD 4005M	GPD 4505M	GPD 5005M



Color



Bone Profile Drill

- When connecting abutment (healing) after implant placement, It is necessary to contour the bone for proper seating of the abutments. (to contour bone to allow for a wider emergence profile restoration)
- To flatten and remove bone that has grown around or over an implant which impedes its restoration. (When use a Abutment (with Healing Abutment))
- When abutment is completely tightened transmucosal recovery time is reduced.

● Sold separately

K

Unit mm | Scale 1 : 1

Code	BPD 4616GN	BPD 5608G
------	-------------------	------------------

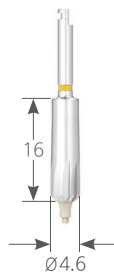

Type

Narrow

Regular

Surgical Tool

Final Drill

· The drill hole is expanded to the final drilling.

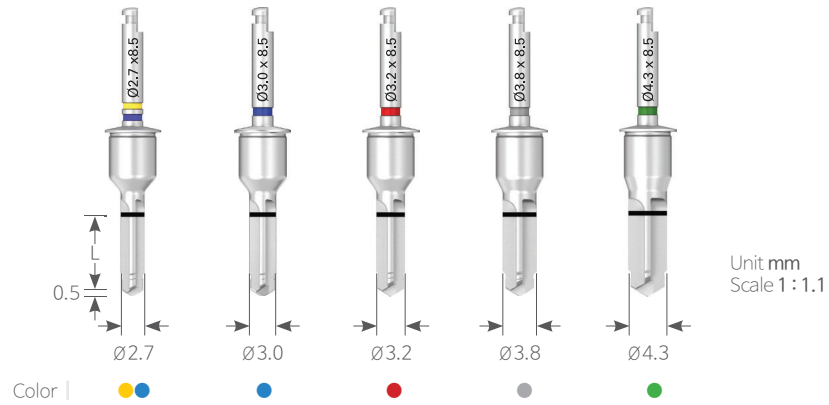

● Sold separately

K D Ø2.7

Unit mm | Scale 1 : 1

Code USD 2705M USD 2707M USD 2708M USD 2710M USD 2711M USD 2713M **USD 2715M**

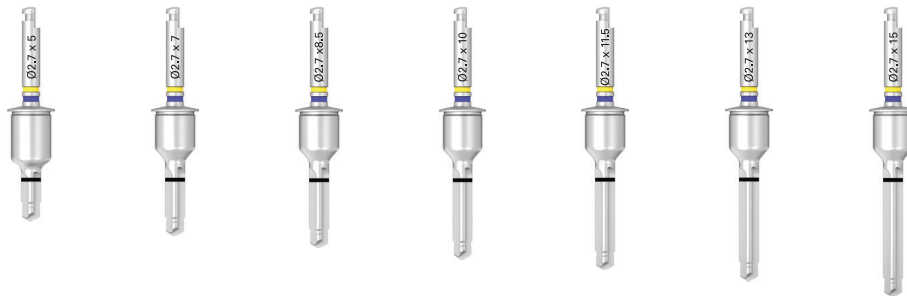

Length | 5 7 8.5 10 11.5 13 15

K D Ø3.0

Unit mm | Scale 1 : 1

Code **USD 3005M** USD 3007M USD 3008M USD 3010M USD 3011M USD 3013M **USD 3015M**



Length | 5 7 8.5 10 11.5 13 15

K D Ø3.2

Unit mm | Scale 1:1

Code **USD 3205** USD 3207M USD 3208M USD 3210M USD 3211M USD 3213M **USD 3215M**

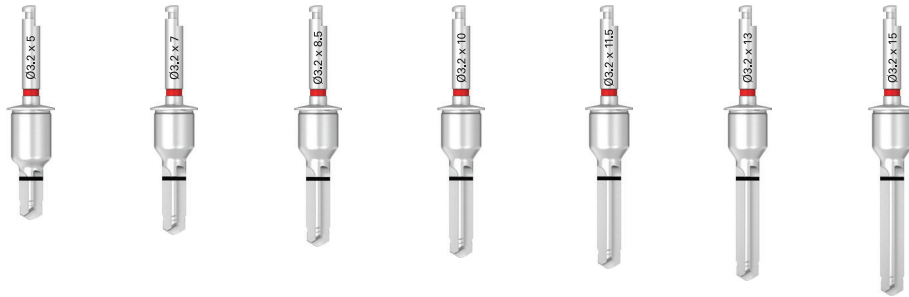

Length | 5 7 8.5 10 11.5 13 15

K D Ø3.8

Unit mm | Scale 1:1

Code **USD 3805** USD 3807M USD 3808M USD 3810M USD 3811M USD 3813M **USD 3815M**

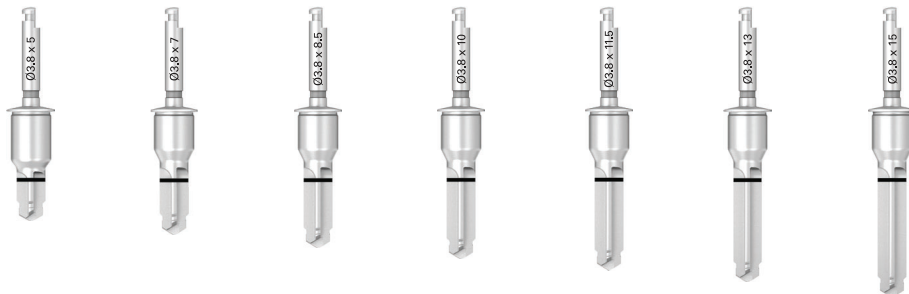

Length | 5 7 8.5 10 11.5 13 15

K D Ø4.3

Unit mm | Scale 1:1

Code **USD 4305** USD 4307M USD 4308M USD 4310M USD 4311M USD 4313M **USD 4315M**



Length | 5 7 8.5 10 11.5 13 15

Surgical Tool

Tap Drill

· Excessive implant placement torque is prevented.

● Sold separately

K

Unit mm | Scale 1:1

Fixture Size	Ø3.8	Ø4.0	Ø4.5	Ø5.0
Code	GNTD 3815	GNTD 4015	GNTD 4515	GNTD 5015



Color



Abutment Profile Drill

· The cortical bone disrupting sitting of the abutment is removed, and emergence profile is formed.

K

Unit mm | Scale 1:1

Code	UAPD 5123M	UAPD 5124M	UAPD 5126M
------	------------	------------	------------



Offset

9

10.5

12

Connector Extension

· Length of the connector is extended during implant placement.

K

Unit mm | Scale 1:1

Code	CE 6508A	CE 6508M	CE 6512A	CE 6512M
------	----------	----------	----------	----------



Type

Ratchet

Machine

Ratchet

Machine

Implant Connector

- Implant is placed according to depth of the fixture and direction of the internal hex planned in advance.
- Recommended use of UF(II) Narrow : 20 times / Be careful about excessive torque of 50Ncm or above.

● Sold separately

K

Unit mm | Scale 1:1

Fixture Size	Ratchet			Machine
Code	Non-Stopper	Stopper	Multi	Non-Stopper



UF II **Narrow**

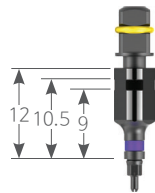

GNIC 5309

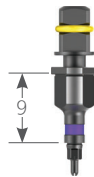

GNIC 5309ST

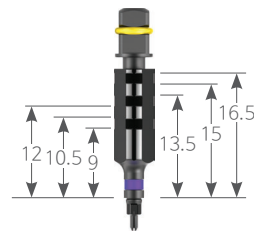

GNIC 5317

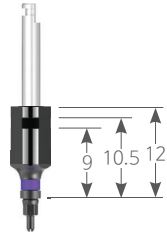

GNICC 5309



UF II **Regular**

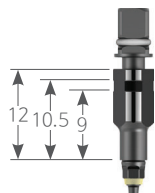

GIC 5309

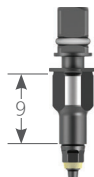

GIC 5309ST

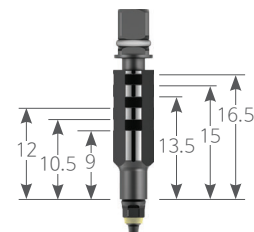

GIC 5317

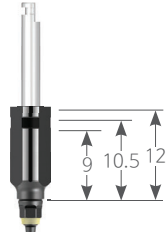

GICC 5309



UF II **Wide**

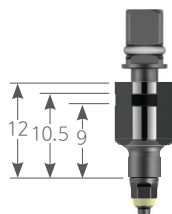

GWIC 6808

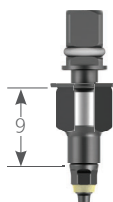

GWIC 6808ST

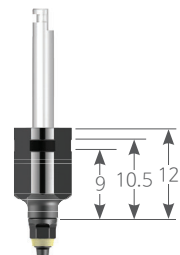

GWICC 6808

Surgical Tool

Screw Driver

K Hex 1.2

Unit mm | Scale 1:1

Code	MD 1222	MD 1230
------	---------	---------



Type

Machine

Machine

Sqaure Screw Driver

K Hex 1.2

Unit mm | Scale 1:1

Code	SHD 1215	SHD 1220
------	----------	----------

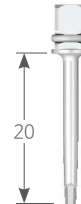
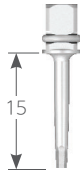

Ratchet

Ratchet

Torque Wrench

· To place the fixture using an implant connector

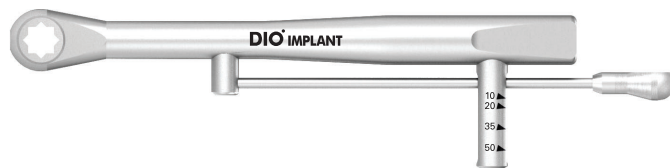

K

Code	DTW 0080
------	----------

DIOnavi. Narrow Kit Kit Code I UF 14

- Kit composed of drill with outstanding cutting force and durability, etc.
- UF(II) Narrow $\varnothing 3.0$ $\varnothing 3.3$ Fixture
- Guide Sleeve : GSL 36, GS36

Unit mm | Drill Scale 1 : 0.9

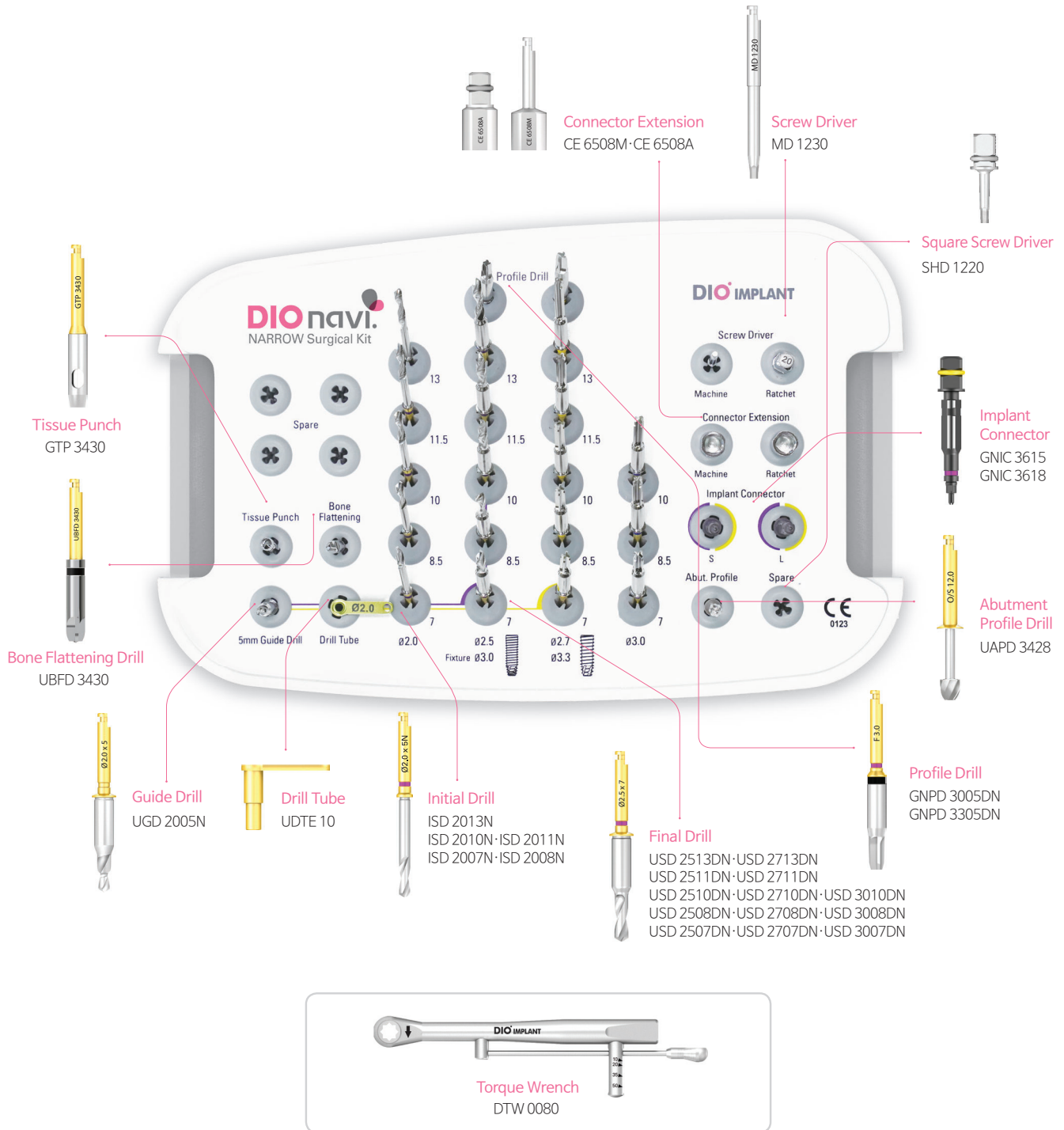

DIONAVI.
DIONAVI. Narrow Kit

Ver B

Surgical Tool

Tissue Punch

- Gingiva in the position of implant placement is incised into a round shape, and the inner double blade is used to remove the gum tissue cut into round shape.



Double blade
Gingiva can be removed stably using a fixed double blade inside the punch (flapless surgery).

Unit mm | Scale 1 : 1.15

K D Ø2.8

Code

GTP 3430

Bone Flattening Drill

- Alveolar crest surface is flattened, and soft tissue remaining in the alveolar crest is removed after using the tissue punch.

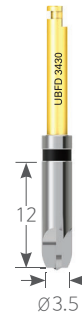

Triple blade
A triple blade is used for stable drilling of the hard alveolar ridge.

Unit mm | Scale 1 : 1.15

K D Ø3.5

Code

UBFD 3430

Guide Drill

- A hole in the bone is initially formed on the bone for easier insertion of the initial drill.



Double stepped drill
Stable drilling can be done due to short double step drill. This is a basic drill to maintain the accuracy of the path.

Unit mm | Scale 1 : 1.15

K D Ø2.0

Code

UGD 2005N

Initial Drill

- It secures accurate depth and direction of drilling performed after achieving accurate hole formation during the initial steps.

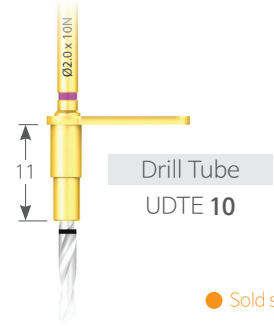

● Sold separately

K D Ø2.0

Unit mm | Scale 1 : 1

Code	ISD 2007N	ISD 2008N	ISD 2010N	ISD 2011N	ISD 2013N	ISD 2015N

Drill Tube

- Guide Drill, Initial Drill을 흔들림 없이 Drilling하기 위해 사용



K D Ø3.5

Unit mm | Scale 1 : 1.15

Code	UDTE 10
------	---------

Profile Drill

- Used to further drill cortical bone in the mandible with bone density of D1 or D2 for the purpose of preventing excessive torque.

K		Unit mm Scale 1 : 1	
Fixture Size	Ø3.0	Ø3.3	
Code	GNPD 3005DN	GNPD 3305DN	



Color

|



Surgical Tool

Final Drill

· Drilling is done by moving down along the passage of leading drill without using a drill tube, while increasing drill size (diameter) according to implant size.

● Sold separately

K D Ø2.5

Unit mm | Scale 1:1

Code USD 2507DN USD 2508DN USD 2510DN USD 2511DN USD 2513DN **USD 2515DN**



Length | 7 8.5 10 11.5 13 15

K D Ø2.7

Unit mm | Scale 1:1

Code USD 2707DN USD 2708DN USD 2710DN USD 2711DN USD 2713DN **USD 2715DN**



K D Ø3.0

Unit mm | Scale 1:1

Code USD 3007DN USD 3008DN USD 3010DN **USD 3011DN** **USD 3013DN** **USD 3015DN**

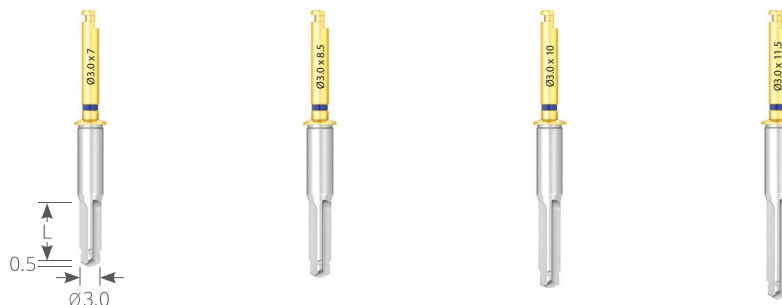

Abutment Profile Drill

- Shape of abutment profile is formed by rotating the functional drill 360 degrees which removes the disruptive alveolar bone around the abutment or H-scan body.

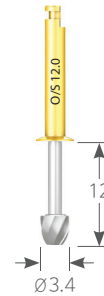

K D Ø3.4

Unit mm | Scale 1 : 1.15

Code

UAPD 3428

Implant Connector

- If depth of placement and position of fixture hexagon are aligned with the guide sleeve projection during placement of the fixture, it is aligned with hex direction of the premade customized abutment.

K Hex 1.7

Unit mm | Scale 1 : 1



Type



Short

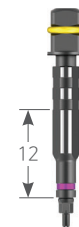

Long

Code

GNIC 3615

GNIC 3618

Connector Extension

- Length of the connector is extended during implant placement.

● Sold separately

K

Unit mm | Scale 1 : 1.2

Code

CE 6508A

CE 6508M

CE 6512A

CE 6512M



Type

Ratchet



Machine



Ratchet



Machine

Surgical Tool

Screw Driver Machine

· Used to connect the abutment screw (for handpiece) using an abutment screw driver for ratchet.

● Sold separately

K Hex 1.2

Unit mm | Scale 1:1



Screw Driver Ratchet

K Hex 1.2

Unit mm | Scale 1:1

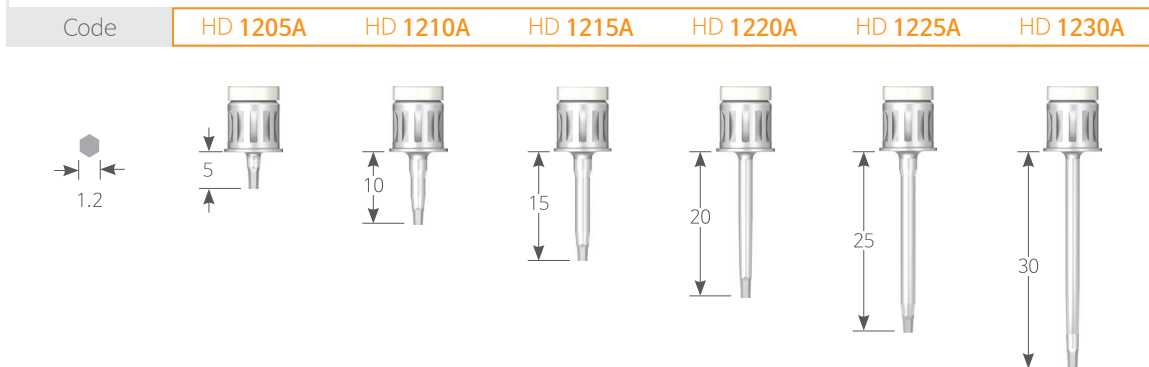

Square Screw Driver

● 별매품

K Hex 1.2

Unit mm | Scale 1:1

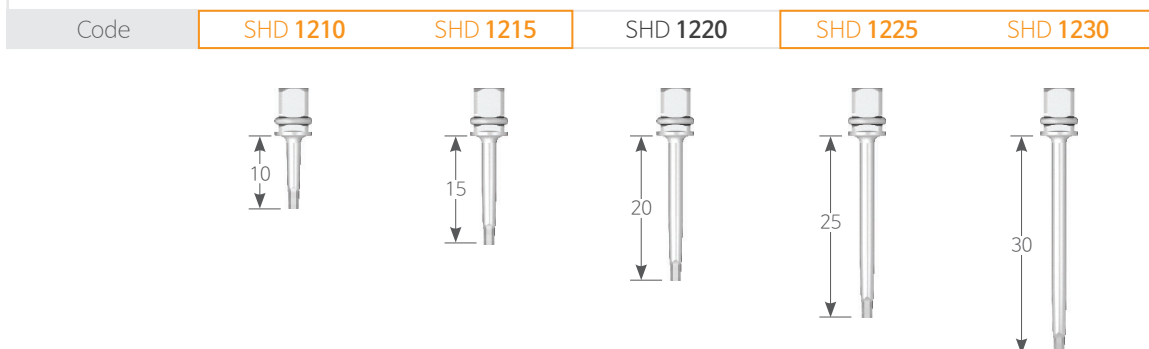

DIOnavi. Wide Kit Kit Code | UF 11

- Kit composed of drill with outstanding cutting force and durability, etc.
- UFII Wide Ø5.5 Ø6.0 Ø6.5 Fixture
- Guide Sleeve : GS 68GN

Unit:mm | Drill Scale 1 : 0.9

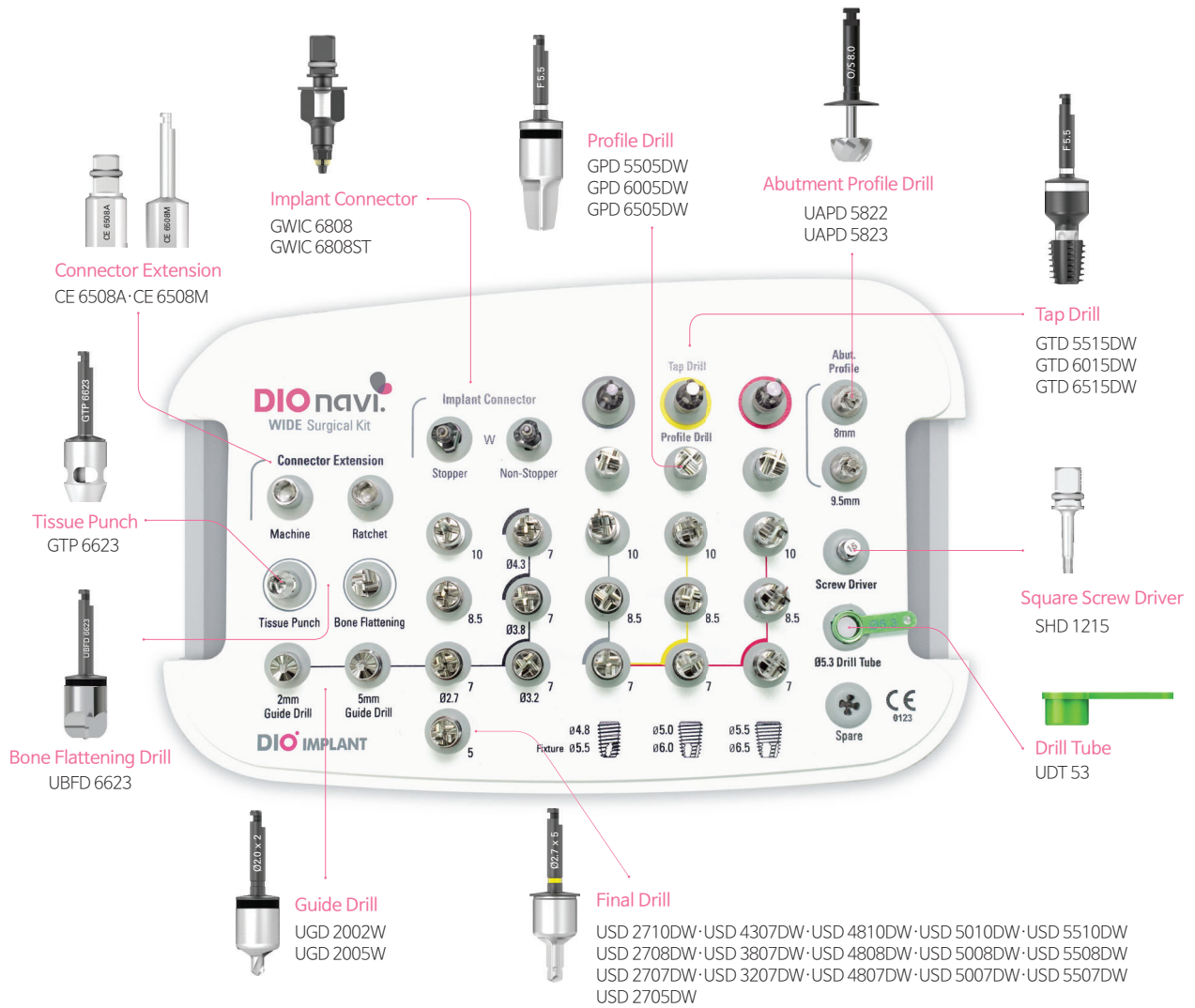

DIONAVI.

DIONAVI. Wide Kit

VerD

Surgical Tool

Tissue Punch

· Gingiva can be removed stably using a fixed blade inside the punch



Unit mm | Scale 1 : 1.15

K D Ø4.5

Code

GTP 6623

Bone Flattening Drill

· Irregular alveolar crest surface is flattened.



Unit mm | Scale 1 : 1.15

K

Code

UBFD 6623

Drill Tube

· Used for drilling of the guide drill and initial drill without oscillation



Unit mm | Scale 1 : 1.2

K

Code

UDT 53

Guide Drill

· A hole is initially formed on the bone for easier insertion of the initial drill.

K D Ø2.0

Unit mm | Scale 1 : 1

Code

UGD 2002W

UGD 2005W



Surgical Tool

Final Drill

· The drill hole is expanded to the final drilling.

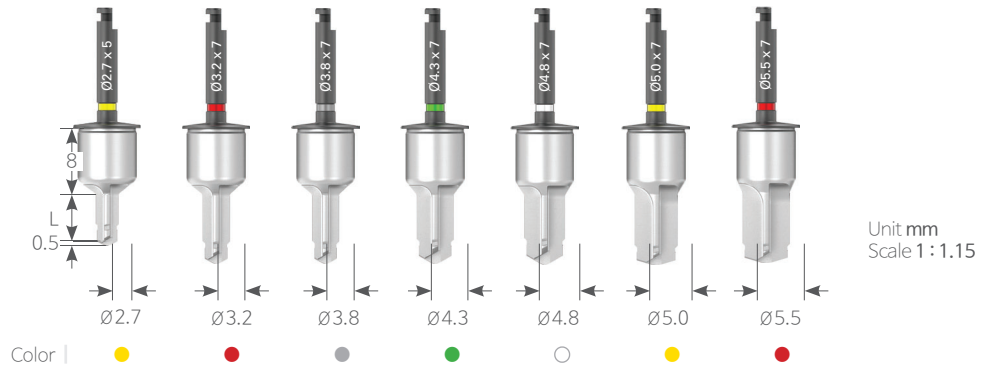

K D Ø2.7

Unit mm | Scale 1:1

Code	USD 2705DW	USD 2707DW	USD 2708DW	USD 2710DW
------	------------	------------	------------	------------

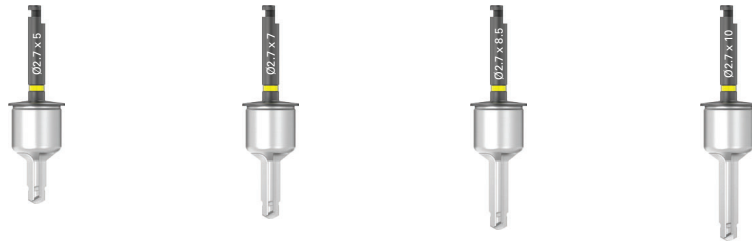

Length	5	7	8.5	10
--------	---	---	-----	----

K Length 7

Unit mm | Scale 1:1

Code	USD 3207DW	USD 3807DW	USD 4307DW
------	------------	------------	------------



Diameter	Ø3.2	Ø3.8	Ø4.3
----------	------	------	------

K D Ø4.8

Unit mm | Scale 1:1

Code	USD 4807DW	USD 4808DW	USD 4810DW
------	------------	------------	------------



Length

7

8.5

10

K D Ø5.0

Unit mm | Scale 1:1

Code	USD 5007DW	USD 5008DW	USD 5010DW
------	------------	------------	------------



Length

7

8.5

10

K D Ø5.5

Unit mm | Scale 1:1

Code	USD 5507DW	USD 5508DW	USD 5510DW
------	------------	------------	------------



Length

7

8.5

10

Surgical Tool

Profile Drill

- Used to further drill cortical bone in the mandible with bone density of D1 or D2 for the purpose of preventing excessive torque

K				Unit mm Scale 1:1		
Fixture Size	Ø5.5	Ø6.0	Ø6.5			
Code	GPD 5505DW	GPD 6005DW	GPD 6505DW			



Color



Tap Drill

- Excessive implant placement torque is prevented.

K				Unit mm Scale 1:1		
Fixture Size	Ø5.5	Ø6.0	Ø6.5			
Code	GTD 5515DW	GTD 6015DW	GTD 6515DW			



Color



Connector Extension

- Length of the connector is extended during implant placement.

K			Unit mm Scale 1:1.1	
Code	CE 6508A	CE 6508M		



Type

Ratchet

Machine

Abutment Profile Drill

· The cortical bone disrupting sitting of the abutment is removed, and emergence profile is formed.

K D Ø5.5

Unit mm | Scale 1:1

Code	UAPD 5822	UAPD 5823
------	-----------	-----------



8



9.5

Offset

Implant Connector

· Implant is placed according to depth of the fixture and direction of the internal hex planned in advance.

· Recommended use of UF(II) narrow: 20 times / Be careful about excessive torque of 50Ncm or above.

K

Unit mm | Scale 1:1

Code	GWIC 6808ST	GWIC 6808
------	-------------	-----------



Stopper Type

8



Non-Stopper Type

9.5

Type

Offset

Square Screw Driver

● Sold separately

K Hex 1.2

Unit mm | Scale 1:1

Code	SHD 1210	SHD 1215	SHD 1220	SHD 1225	SHD 1230
------	----------	----------	----------	----------	----------

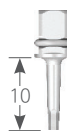

10

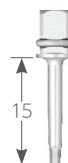

15

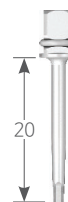

20



25



30

DIOnavi. Flapless Crestal Sinus Kit Kit Code | SMK 02

Unit mm | Drill Scale 1 : 0.9

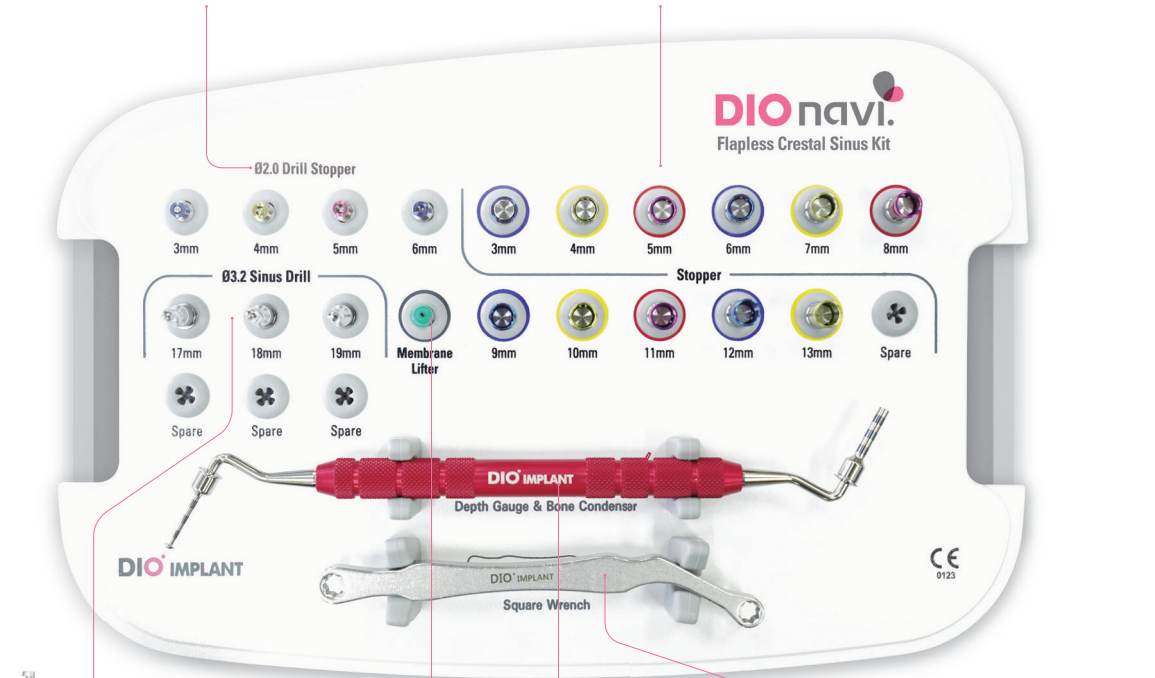

Sinus Round Drill
GSRD 3217
GSRD 3218
GSRD 3219



Membrane Lifter
WML 6627



Square Wrench
DSW 050



Depth Gauge & Bone Condenser
GSDB 2619

Surgical Tool

Ø2.0 Drill Stopper

- This is used to connect to the Ø2.0 initial drill of DIOnavi. Master to maintain constant depth during surgery.
- Range of length is 3~6mm with 1mm interval and anodizing and laser marking are done for each length.

K		Unit mm Scale 1:1			
Code	GST 2030BL	GST 2040YE	GST 2050RD	GST 2060BL	

3

4

5

6

Sinus Round Drill

- Dome shaped tip is designed to prevent damaging of the membrane during drilling.
- Depth must be adjusted using a stopper.
- Non-irrigation and low-speed drilling (50rpm)

● Sold separately

K D Ø3.2		Unit mm Scale 1:1			
Code	GSRD 3217	GSRD 3218	GSRD 3219	GSRD 3221	

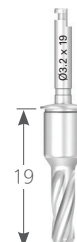
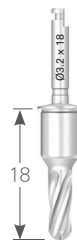
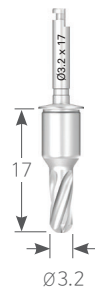

Drill Stopper For crestal approach

- This is used by connecting to the Ø3.2 round drill of Flapless Crestal Sinus Kit.
- Range of length is 3~13mm with 1mm interval to maintain constant depth during surgery. Anodizing and laser marking are done for each length.

K		Unit mm Scale 1:1					
Code	GST 03BL	GST 04YE	GST 05RD	GST 06BL	GST 07YE	GST 08RD	

3

4

5

6

7

8

Code	GST 09BL	GST 10YE	GST 11RD	GST 12BL	GST 13YE
------	----------	----------	----------	----------	----------

9

10

11

12

13

Depth Gauge & Bone Condenser

- After checking the thickness of the residual bone and whether the membrane is lifted, push in the bone into the lifted sinus.
- After separating the Guide, make sure to use it attaching the Stopper.

K	Unit mm
Code	GSDB 2619



Membrane Lifter

K	Unit mm
Code	WML 6627



Square Wrench

K	Unit mm
Code	DSW 050



Membrane Lifter Tube

- Syringe ※ Separately sold product

K	Unit mm
Code	MLT 40300

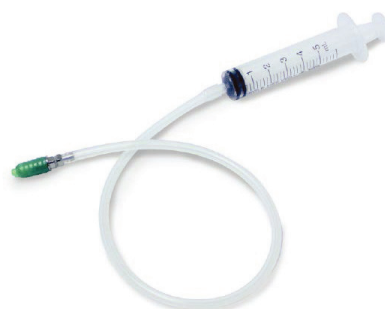

DIONavi. Special Kit Kit Code | SGF 02

· Kit composed of drill with outstanding cutting force and durability, etc.

Unit mm | Drill Scale 1 : 0.9

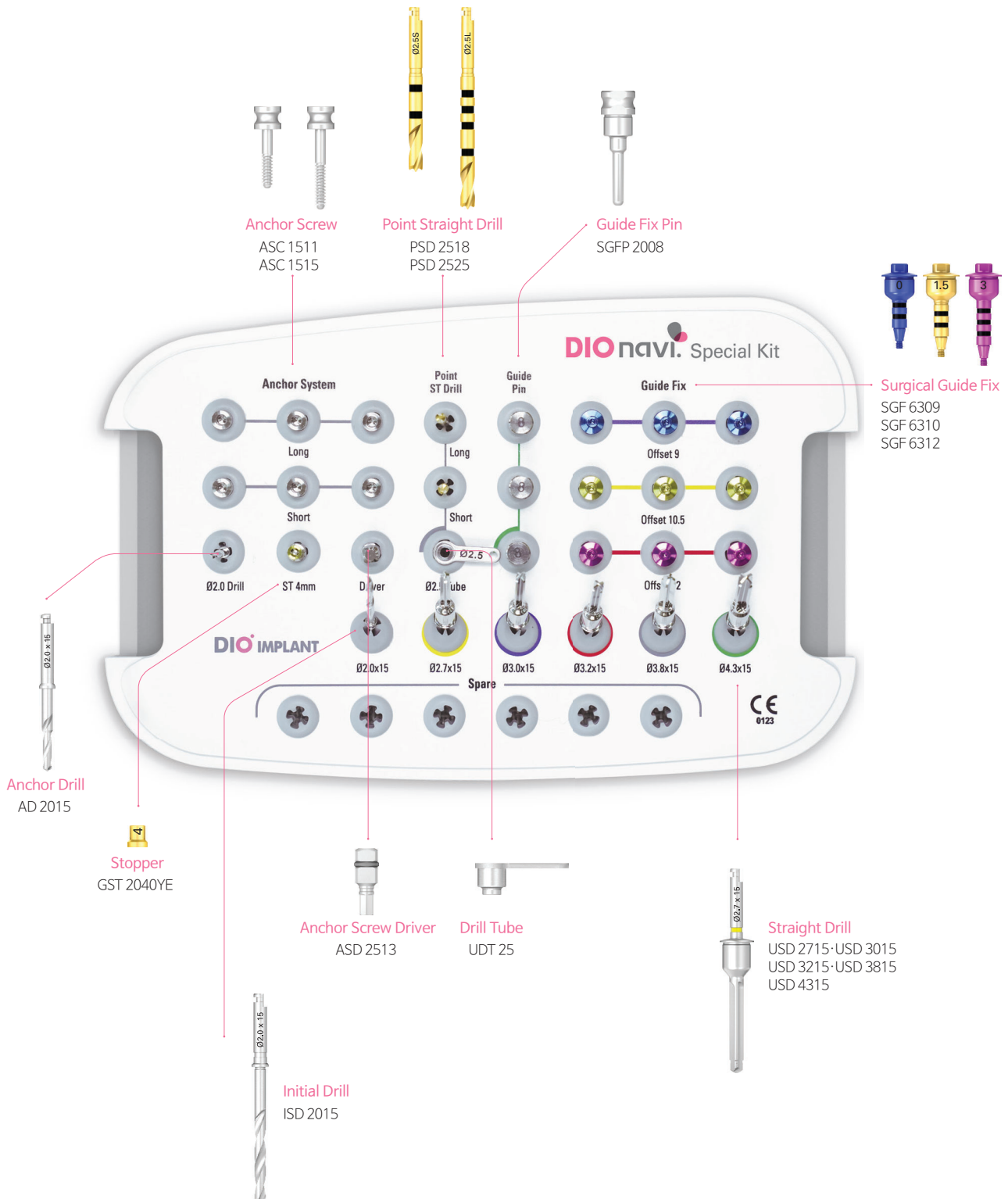

Ver B

Surgical Tool

Anchor Drill

- A hole is formed to insert an anchor pin into the bone for the purpose of fixating the surgical guide.

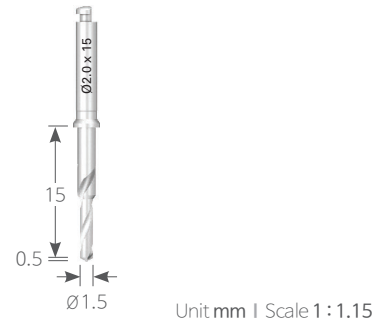

K D Ø1.5

Code

AD 2015

Stopper

- This is used when connecting to the Ø2.0 initial drill. Constant depth is maintained during surgery.



K D Ø2.9

Unit mm | Scale 1 : 1.15

Code

GST 2040YE

Anchor Screw

- Used to connect the anchor screw using an anchor screw driver for ratchet

K D Ø2.0

Unit mm | Scale 1 : 1

Code

ASC 1511

ASC 1515

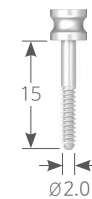
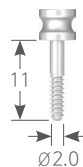

Anchor Screw Driver

- Used to connect the anchor screw using an anchor screw driver for ratchet



K

Unit mm | Scale 1 : 1.15

Code

ASD 2513

Surgical Tool

Initial Drill



Ø2.0

Unit mm | Scale 1 : 1.15

K D Ø2.0

Code

ISD 2015

Drill Tube



K

Unit mm | Scale 1 : 1.2

Code

UDT 25

Point Straight Drill

- Use of a drill tube (UDT 25) exclusive for the instrument (with a shape that prevents slipping on the bone) to form the guide hole in accurate position

K D Ø2.5

Unit mm | Scale 1 : 1

Code

PSD 2518

PSD 2525

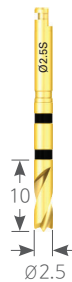

Ø2.5

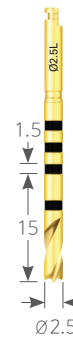

Ø2.5

Straight Drill

K Length 15

Unit mm | Scale 1 : 1

Code	USD 2715	USD 3015	USD 3215	USD 3815	USD 4315
Color					



Surgical Guide Fix Pin

- Used after $\varnothing 2.0$ drilling to insert a surgical guide fix pin into the hole to fix the surgical guide in place and prevent shaking (side shaking is prevented after fixing)



$\varnothing 2.0$

Unit mm | Scale 1 : 1.15

K

Code	SGFP 2008
------	-----------

Surgical Guide Fix

- Used to fix the surgical guide in place and prevent movement by connecting to the fixture placed earlier (side shaking is prevented after fixing)

K

Unit mm | Scale 1 : 1

Code	SGF 6309	SGF 6310	SGF 6312
Offset	 9	 10.5	 12

Surgical Tool

Metal Needle

- Place the Metal needle tip deep into the osteotomy site, in order to prevent any damage caused by over-heating of the bone and complete removal of remaining tissues and particles at drilled bone cavity.
- Recommended capacity of the syringe : 30~50cc (Refrigerate before surgery)

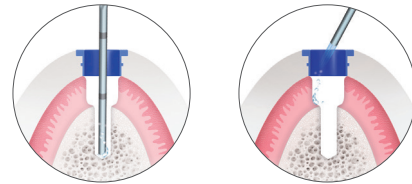
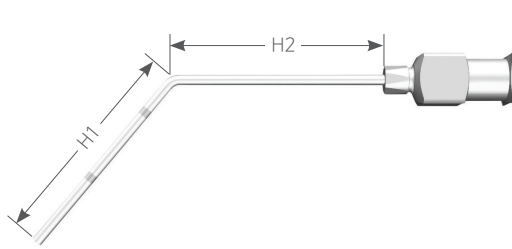

O
Place the metal needle tip deep into the osteotomy site.

X
With the needle tip not all the way down to osteotomy it is hard to irrigate

K		Unit mm Scale 1 : 1.15	
Code		MNTE	MNTL
Height 1		30	25
Height 2		50	25

DIONavi. Drill Plate

- To increase efficiency and convenience of sterilizing drills and restoring them into the KIT set after DIONavi. Surgery
- Sterilizable material
- Size : 200×140×30 (mm)
- ※ Non-medical devices



K		Unit mm
Code	NP 01	

DIO
www.dionavi.com

SURGICAL KIT

SURGICAL KIT

Sinus Master Kit Kit Code | SMK 01

- **Crestal Approach Technic**
Sinus Technic based on low-speed drilling (50~100rpm) and stopper that perforates the inferior cortical wall and lifts the membrane.
- **Lateral Approach Technic**
Round drill or core drill can be selected. The membrane can be lifted and based on low-speed drilling (50~100rpm) and stopper.

Unit mm | Drill Scale 1 : 0.9

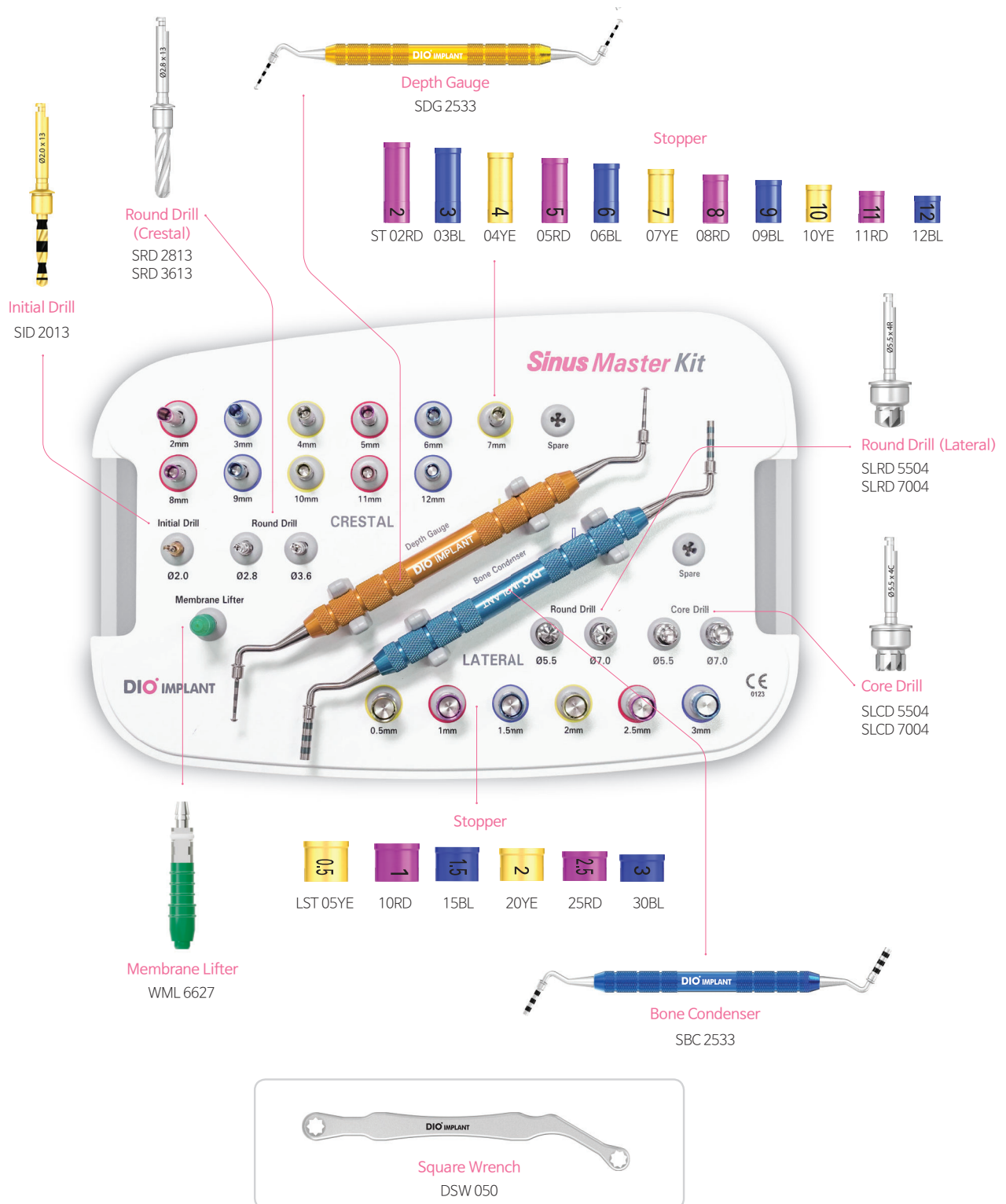

Surgical Tool Crestal

Ø2.0 Intial Drill

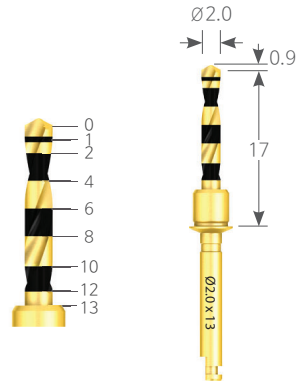

K D Ø2.0

Unit mm | Scale 1 : 1.2

Code

SID 2013

Round Drill

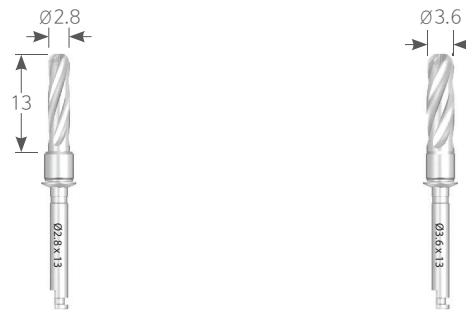

K Length 13

Unit mm | Scale 1 : 1.2

Code

SRD 2813

SRD 3613

Stopper

· · Stopper must be used for adjusting depth of the drill. It is distinguished by color and number.

K

Unit mm | Scale 1 : 1

Code	ST02RD	03BL	04YE	05RD	06BL	07YE	08RD	09BL	10YE	11RD	12BL
------	--------	------	------	------	------	------	------	------	------	------	------



Drilling Length	2	3	4	5	6	7	8	9	10	11	12
Stopper Length	15	14	13	12	11	10	9	8	7	6	5

Surgical Tool Crestal

Membrane Lifter



K

Unit mm | Scale 1 : 1.2

Code

WML 6627

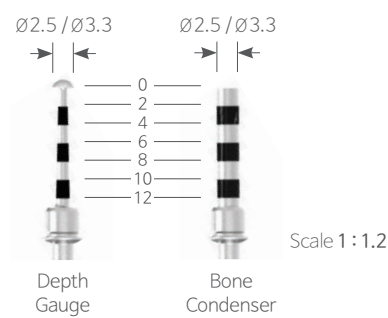

Depth Gauge

K

Unit mm

Code

SDG 2533



Bone Condenser

K

Unit mm

Code

SBC 2533



Surgical Tool Lateral

Round Drill

K

Unit mm | Scale 1:1

Code	SLRD 5504	SLRD 7004
------	-----------	-----------

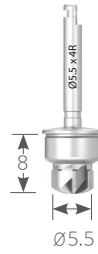

Core Drill

K

Unit mm | Scale 1:1

Code	SLCD 5504	SLCD 7004
------	-----------	-----------

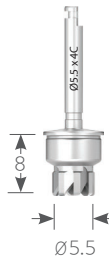

Stopper

· Stopper must be used for adjusting depth of the drill. It is distinguished by color and number.

K

Unit mm | Scale 1:1

Code	LST 05YE	10RD	15BL	20YE	25RD	30BL
------	----------	------	------	------	------	------



Drilling Length	0.5	1	2	1.5	2.5	3
Stopper Length	7.5	7	6	6.5	5.5	5

Surgical Protocol

Lateral Approach Technic

· Round drill or core drill can be selected. The membrane can be lifted and based on low-speed drilling (50~100rpm) and stopper.

Drilling Round Drill

Rounded tip to perform drilling

Caution

The stopper must be used. Irrigation at 1,200~1,400rpm

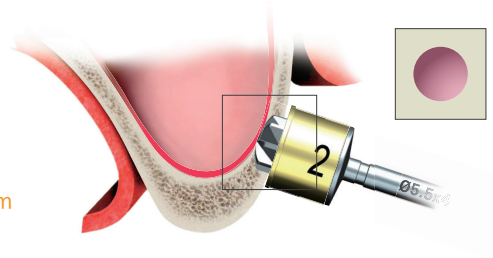

Drilling Core Drill

The edge of the rounded tip only can perform drilling
Beware of the remaining bone chips returning to original position after lifting of the maxillary sinus.

Caution

The stopper must be used. Irrigation at 600~800rpm

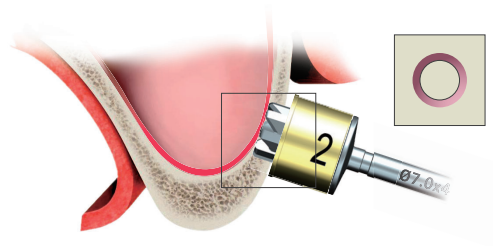

Lifting of the sinus membrane Sinus Lift

Lifting of the membrane on the lateral side

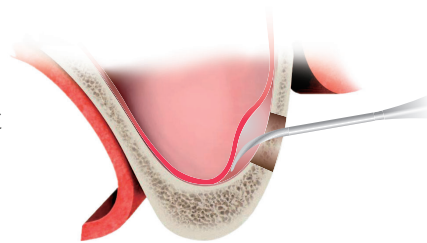

Crestal Approach Technic

· Sinus Technic based on low-speed drilling (50~100rpm) and stopper that perforates the inferior cortical wall and lifts the membrane.

Drilling Initial Drill

Drilling is done 1~2mm short from the floor of the maxillary sinus measured by CT after attaching a stopper.

Caution

The stopper must be used to adjust depth.
Non-irritation and low-speed drilling at 50rpm

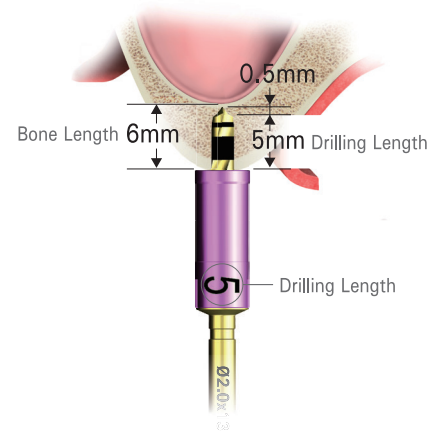

Sinus drill to perforate the bone underneath the maxillary sinus

Drilling is done to the same length as height of the residual bone of the maxillary sinus measured on CT after attaching a stopper.

Caution

The stopper must be used to adjust depth.
Non-irritation and low-speed drilling at 50rpm

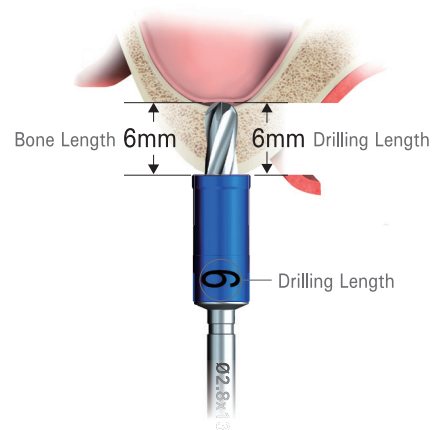

Membrane lifter to lift the sinus membrane

The membrane lifter is used to inject saline solution into the osteotomy site.

Caution

Amount of injection measurement starts when pressure is felt, excluding the first 0.2cc~0.5cc before pressure is applied.

※ Amount of injection before pressure can differ according to height and expansion of the bone. For 1 mm of sinus lifted, 0.1 cc is injected.

Caution

If inferior border (A) of the maxillary sinus is well open

If pressure can be felt during injection of saline solution, the membrane is lifted and the pressure drops and saline solution injected.

If inferior border (A) of the maxillary sinus is not open well

After pressure felt from injection of saline solution, no more pressure can be applied or the nozzle is pushed out.

→ Drill the sinus drill 1 mm deeper and retry.

Aspiration of saline solution with the nozzle kept in the hole

If negative pressure results after aspiration of injected saline solution mixed with blood, the membrane is fully lifted.

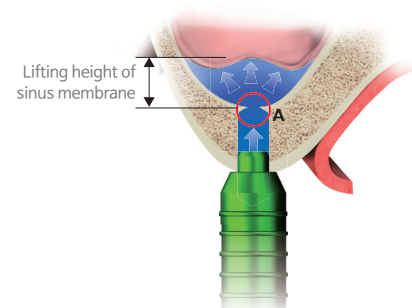

Surgical Protocol

Sinus drill (2nd) to open and expand inferior border of the maxillary sinus.

After lifting the maxillary sinus membrane, the sinus drill is used to drilled 1 mm deeper to expand the entrance of inferior border of the maxillary sinus.

Caution The stopper must be used to adjust depth.

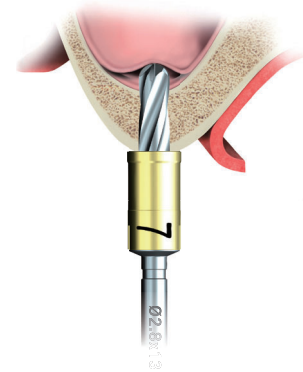
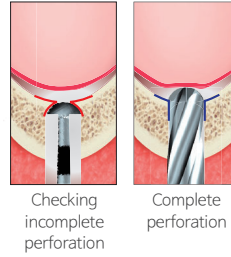

Bone condenser to inject bone graft material

The bone condenser is used to push bone graft material into the maxillary sinus through the osteotomy site.

Caution

The stopper must be used to adjust depth.
Non-irrigation, low-speed drilling at 50rpm.

Caution

Determine volume of bone graft material.

When pressure is felt during injection of saline solution, the membrane is lifted.

Lifting height of the sinus membrane (mm)		1	2	3	4	5	6	7	8	9	10
Bone graft GBR (cc)	If implant is placed	0.1	0.2	0.3	0.4	0.5	0.6	0.7	0.8	0.9	1.0
	If implant is not placed	0.3	0.6	0.9	1.2	1.5	1.8	2.1	2.4	2.7	3.0

Dispersion of bone graft material

Insert a depth gauge into the maxillary sinus and rotate it to evenly disperse bone graft material.

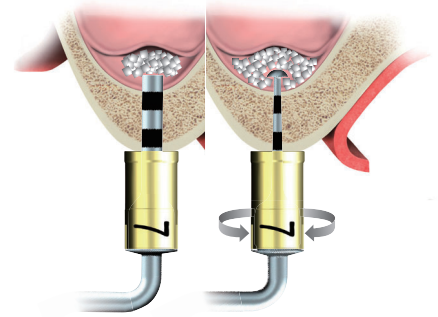

Final Drilling Final Drill

Drill 2mm deeper than depth of the sinus drill used earlier.

Caution Use a drill shorter than implant.

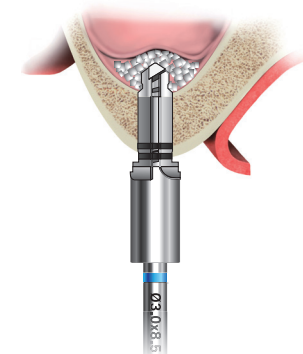

Placement of Implant

Implant that enters into the maxillary sinus pushes bone graft material away to disperse it. If amount of residual bone is 4mm or larger, satisfactory initial fixing force can be obtained. Also, temporary prosthesis can be restored immediately upon placement of implant.

Caution

If remaining bone is very thin with thickness of 3mm or less and initial fixing of implant fails, only bone graft on the maxillary sinus is performed without implant placement.

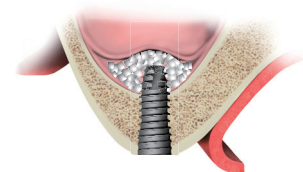

Dr.SOS+ Kit Kit Code | DRS 02

Problems like fracture of screw from excessive torque, wearing of connections, and jamming of foreign matters during prosthetic part of implant installation are resolved.

Unit:mm | Drill Scale 1 : 0.9

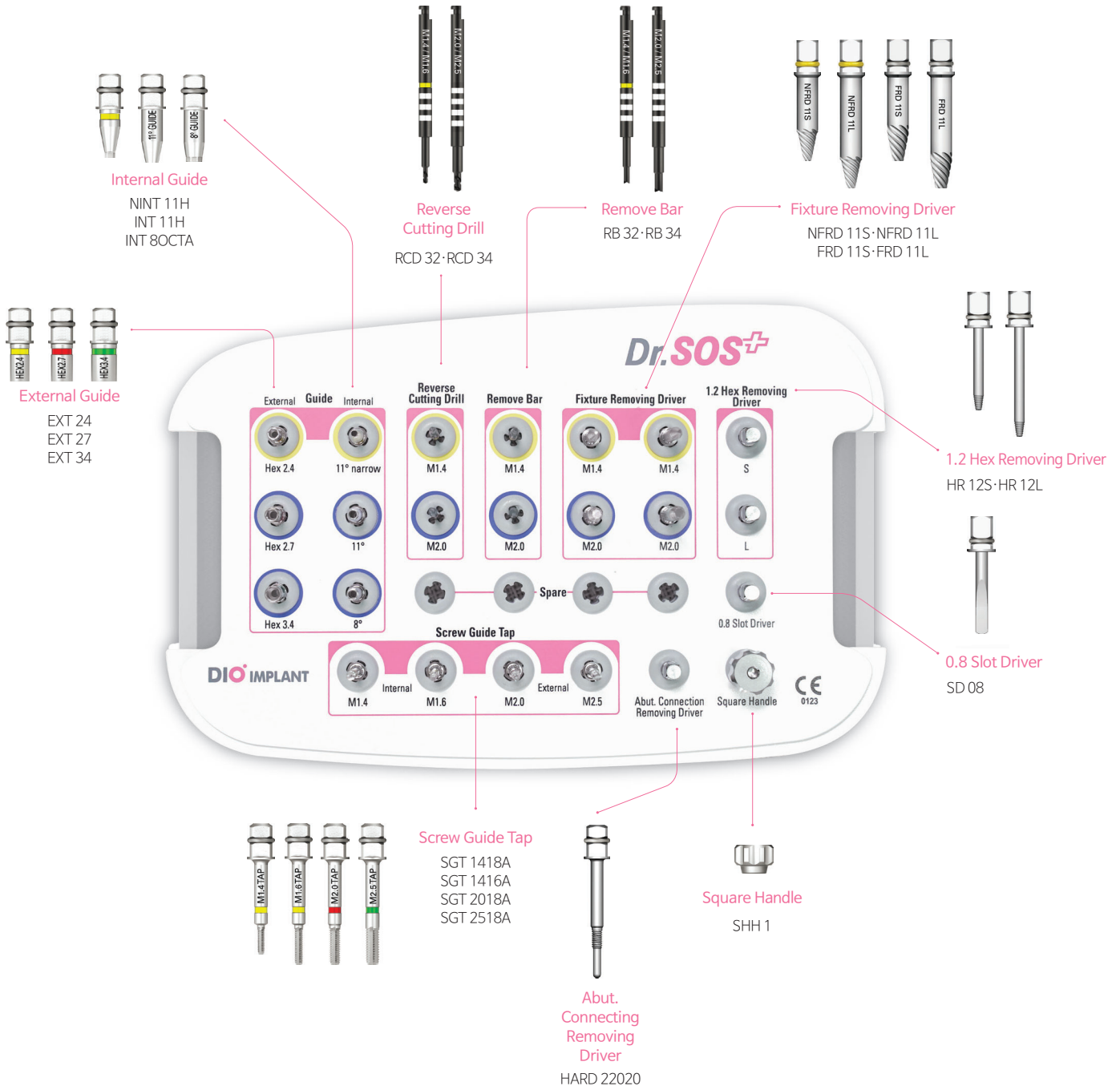

SURGICAL KIT
Dr.SOS Kit



Surgical Tool

Internal Guide

· Guide for accurate entry of the Remove Bar and Reverse Cutting Drill into the fixture

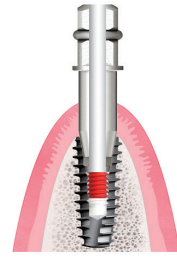

K UFII Narrow

● Sold separately

Unit mm | Scale 1:1

Code	NINT 11H	NINT 11N
Type	Hex	Non-Hex

K UFII Regular / Wide

Code	INT 11H	INT 11N
Type	Hex	Non-Hex



K Non-Sub. 8°

Code	INT 8Octa	INT 8N
Type	Octa	Non-Octa

External Guide

K Hex

Unit mm | Scale 1:1

Code	EXT 24	EXT 27	EXT 34
			

Fixture Removing Driver

- Allows the removal of placed implant by inserting to the fixture and turning anti-clockwise.

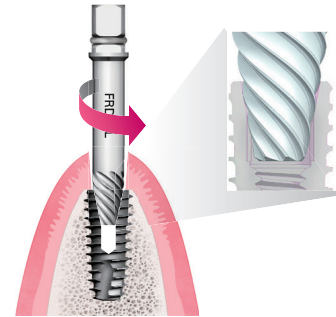

K

Unit mm | Scale 1:1

Fixture Size	UFII Narrow · External NF		UFII Regular · Wide	
Code	NFRD 11S	NFRD 11L	FRD 11S	FRD 11L



Type

Short

Long

Short

Long

1.2 Hex Removing Driver

- When use of the 1.2 Hex driver is not possible due to microorganisms in the 1.2 Hex connection part or the screw is stripped, use the removing driver for the removal of abutments or screws by inserting and turning anti-clockwise.

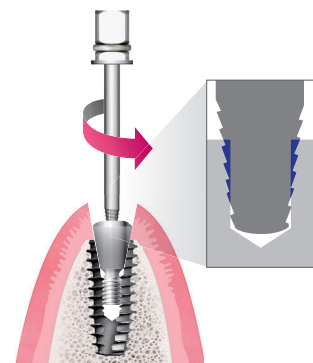

K Hex 1.2

Unit mm | Scale 1:1

Code	HR 12S	HR 12L
------	--------	--------





Surgical Tool

Remove Bar

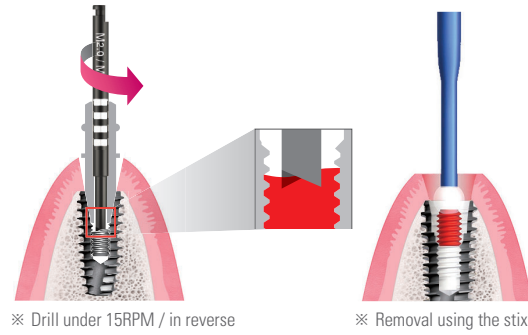
- Used to remove fractured abutment screws by attaching the bar's blade end with the residual surface and turning anti-clockwise.





K		Unit mm Scale 1 : 1	
Code	RB 32	RB 34	
Type	 M1.4 / 1.6	 M2.0 / 2.5	

Reverse Cutting Drill

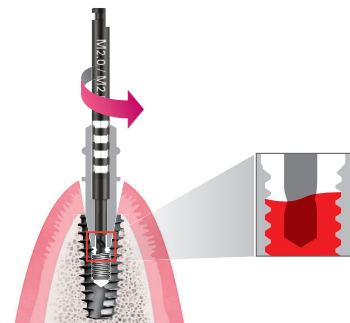
- Used to remove fractured abutment screws by inserting the drill to the fixture and turning anti-clockwise.





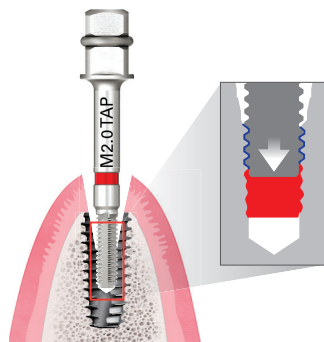

K		Unit mm Scale 1 : 1	
Code	RCD 32	RCD 34	
Type	 M1.4 / 1.6	 M2.0 / 2.5	

Screw Guide Tap

- Allows the restoral of distorted or damaged screw threads which hinder abutment-to-fixture attachment, caused by the penetration of microorganisms in the connection part or stripping of the screw thread.



K UFI II Narrow / External Narrow		Unit mm Scale 1:1			
Code	SGT 1418A	SGT 1416A	SGT 2018A	SGT 2518A	
					
	Ø1.4	Ø1.6	Ø2.0	Ø2.5	
Color	●	●	●	●	

※ This catalog contains all products of DIO Corporation.

Please check with your local sales office and your sales representative if you are able to order products.